

CATÁLOGO DE **PRODUCTOS**

ELÉCTRICOS



1x20A



**PROFESIONAL
TOOL**

BRE-4500 REF C 2.51
PZA | BREAKER P/EMPOTR.QP 1X20A CLAS/
FM/Y
REF A=1.57 REF B=2.39

30 A



**PROFESIONAL
TOOL**

BRE-4502 REF C 2.51
PZA | BREAKER P/EMPOTR.QP 1X30A CLA/
DB/FM
REF A=1.57 REF B=2.39

1x40A



Q7

BRE-4504 REF C 3.09
PZA | BREAKER P/EMPOTR.QP 1X40A CLAS/
FM/Y
REF A=1.93 REF B=2.93

1x60 A



**CLASSIC
LUX**

BRE-4508 REF C 3.09
PZA | BREAKER P/EMPOTR.QP 1X60A CLAS/
FM/Y
REF A=1.93 REF B=2.93

2x100A



**FM
FERMETAL**

BRE-4522 REF C 11.21
PZA | BREAKER P/EMPOTR.QP 2X100A CLAS/
FM/Y
REF A=7 REF B=10.65

1x20A



V-TEG

BRE-4540 REF C 3.59
PZA | BREAKER SUPERFIC.QC 1X20A TRIC/
VTEG
REF A=2.24 REF B=3.42

1x32A



Q7

BRE-4542 REF C 3.54
PZA | BREAKER SUPERF.QC 1X30A CLA/DB/
FM/Y
REF A=2.21 REF B=3.36

1x40A



Q7

BRE-4544 REF C 3.87
PZA | BREAKER SUPERF.QC 1X40A CLAS/FM/
YAI
REF A=2.41 REF B=3.67

1x50A



V-TEG

BRE-4546 REF C 4.62
PZA | BREAKER SUPERFIC.QC 1X50A TRIC/
VTEG
REF A=2.88 REF B=4.39

1x60A



BRE-4548 REF C 4.03
PZA | BREAKER SUPERF. QC 1X60A CLAS/FM/
YAI
REF A=2.52 REF B=3.83

2x40A



BRE-4556 REF C 7.08
PZA | BREAKER SUPERF. QC 2X40A CLAS/FM/
VTEG
REF A=4.42 REF B=6.73

1x50A



BRE-4620 REF C 12.67
PZA | BREAKER P/EMPOTRAR THQL 1X50A
GE
REF A=7.91 REF B=12.04

3x30 A



BRE-4652 REF C 47.49
PZA | BREAKER P/EMPOTRAR THQL 3X30A
GE
REF A=29.65 REF B=45.12

3x50 A



BRE-4656 REF C 63.91
PZA | BREAKER P/EMPOTRAR THQL 3X50A
GE
REF A=39.89 REF B=60.72

3x60 A



BRE-4658 REF C 63.91
PZA | BREAKER P/EMPOTRAR THQL 3X60A
GE
REF A=39.89 REF B=60.72

3x70 A



BRE-4660 REF C 82.63
PZA | BREAKER P/EMPOTRAR THQL 3X70A
GE
REF A=51.58 REF B=78.51

3x100A



BRE-4662 REF C 85.46
PZA | BREAKER P/EMPOTRAR THQL 3X100
GE
REF A=53.35 REF B=81.2

3x15 A



BRE-4666 REF C 10.05
PZA | BREAKER SUPERFIAL THQC 1X15A GE
REF A=6.27 REF B=9.55

1x20 A



BRE-4668 REF C 12.05
PZA | BREAKER SUPERFICIAL THQC 1X20A GE

REF A=7.52 REF B=11.45

1x50 A



BRE-4674 REF C 12.05
PZA | BREAKER SUPERFICIAL THQC 1X50A GE

REF A=7.52 REF B=11.45

2x200A



BRE-4875 REF C 269.95
PZA | BREAKER INDUSTRIAL TQD 2X200 AMP GE

REF A=168.51 REF B=256.47

1x15 A



SIEMENS

BRE-5000 REF C 9.81
PZA | BREAKERS P/EMBTIR QP 1 X15A SIEMENS/LUMIN

REF A=6.12 REF B=9.32

1x50 A



BRE-5040 REF C 9.75
PZA | BREAKERS P/EMBTIR QP 1X50A SIEM/LUM

REF A=6.09 REF B=9.26

1x60 A



BRE-5050 REF C 9.75
PZA | BREAKERS P/EMBTIR QP 1 X60 A LUMIN

REF A=6.09 REF B=9.26

2x90 A



BRE-5140 REF C 6.17
PZA | BREAKERS P/EMBTIR QP 2 X90 A LUMIN

REF A=3.85 REF B=5.86

2x20 A



SIEMENS

BRE-5152 REF C 34.48
PZA | BREAKER.P/EMB.QP 2 X20A SIEMENS

REF A=21.52 REF B=32.76

2x30 A



SIEMENS

BRE-5153 REF C 34.48
PZA | BREAKER.P/EMB.QP 2 X30A SIEMENS

REF A=21.52 REF B=32.76

2x40 A

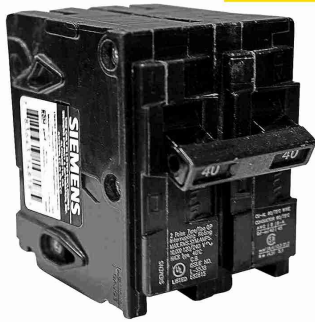

SIEMENS

BRE-5155 REF C 39.2
PZA | BREAKER.P/EMB.QP 2 X40A SIEMENS

REF A=24.47 REF B=37.24

2x100A



SIEMENS

BRE-5158 REF C 66.46
PZA | BREAKER.P/EMB.QP 2 X100A SIEMENS

REF A=41.48 REF B=63.14

3x20 A



BRE-5170 REF C 19.5
PZA | BREAKERS P/EMBTIR QP 3 X20 A LUMIN

REF A=12.17 REF B=18.53

3x30 A



BRE-5180 REF C 19.5
PZA | BREAKERS P/EMBTIR QP 3 X30 A LUMIN

REF A=12.17 REF B=18.53

3x40 A



BRE-5190 REF C 19.5
PZA | BREAKERS P/EMBTIR QP 3 X40 A LUMIN

REF A=12.17 REF B=18.53

3x50 A



BRE-5200 REF C 19.5
PZA | BREAKERS P/EMBTIR QP 3 X50 A LUMIN

REF A=12.17 REF B=18.53

3x60 A



BRE-5210 REF C 19.5
PZA | BREAKERS P/EMBTIR QP 3 X60 A LUMIN

REF A=12.17 REF B=18.53

3x70 A



BRE-5220 REF C 19.5
PZA | BREAKERS P/EMBTIR QP 3 X70 A LUMIN

REF A=12.17 REF B=18.53

3x90 A



BRE-5230 REF C 19.5
PZA | BREAKERS P/EMBTIR QP 3 X90 A LUMIN

REF A=12.17 REF B=18.53

3x100A



LUMINEX

BRE-5240 REF C 28.68
PZA | BREAKERS P/EMBTIR QP 3 X100A
LUMIN
REF A=17.9 REF B=27.25

1x15 A



LUMINEX

BRE-5600 REF C 5.02
PZA | BREAKERS SUPERFICIAL QC1X15 A
LUMIN
REF A=3.13 REF B=4.77

1x50 A



LUMINEX

BRE-5640 REF C 5.02
PZA | BREAKERS SUPERFICIAL QC1X50 A
LUMIN
REF A=3.13 REF B=4.77

1x60 A



LUMINEX

BRE-5650 REF C 5.02
PZA | BREAKERS SUPERFICIAL QC1X60 A
LUMIN
REF A=3.13 REF B=4.77

**3x160 A
660 V**



BRE-5890 REF C 146.48
PZA | BREAK.IND.TRIF/CA 3X150A 660V
EXCELI
REF A=91.44 REF B=139.17

**3x225 A
660 V**



BRE-5910 REF C 89.49
PZA | BREAK.IND.TRIF/CA 3X225A 660V
CLA/DB
REF A=55.86 REF B=85.02

**3x250 A
660 V**



BRE-5912 REF C 167.79
PZA | BREAK.IND.TRIF/CA 3X250A 660V
CLA/DB
REF A=104.74 REF B=159.41

3x300 A



BRE-5914 REF C 201.35
PZA | BREAK.IND.TRIF.KI/NF 3X300A CLA/DB
REF A=125.69 REF B=191.29

3x350 A



BRE-5916 REF C 201.35
PZA | BREAK.IND.TRIF.KI/NF 3X350A CLAS/
DB
REF A=125.69 REF B=191.29



**26 A
380 V**



BRE-6020 REF C 4.25
PZA | INTERRUPT. BIPOL. 26Amp. 380V 602 ORIX
REF A=2.66 REF B=4.04

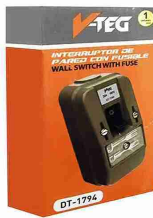

26 A



BRE-6025 REF C 4.09
PZA | INTERRUPTOR BIPOL. 26Amp T/602 VTEG
REF A=2.56 REF B=3.89



**26 A
380 V**



BRE-6027 REF C 4.82
PZA | INTERRUPT. IND. BIPOLAR 26A 602 TRIC
REF A=3.01 REF B=4.58



32A



BRE-6043 REF C 5.78
PZA | INTERRUPTOR IND. TRIPO. 32amp SP 603
REF A=3.61 REF B=5.49

32 A



BRE-6046 REF C 5.73
PZA | INTERRUPT. IND. BIPO. P/EMP. 32A 642 ORI
REF A=3.57 REF B=5.44

3 PATAS



BRE-7003 REF C 0.45
PZA | UNA P/BREAKERS 3 PATA
REF A=0.28 REF B=0.43



**12AWG
100M**



NORMAS: ASTM B566
ISO 9001
600V 90°c/105°c
composición: 100% COBRE



CBL-0730 REF C 72.67
RLL | CABLE THHN 12 100% COBRE BLANC VTEG
REF A=45.36 REF B=69.04

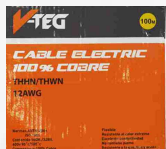

**12AWG
100M**



NORMAS: ASTM B566
ISO 9001
600V 90°c/105°c
composición: 100% COBRE



CBL-0735 REF C 72.67
RLL | CABLE THHN 12 100% COBRE NEGRO VTEG
REF A=45.36 REF B=69.04



**12AWG
100M**



NORMAS: ASTM B566
ISO 9001
600V 90°c/105°c
composición: 100% COBRE



CBL-0740 REF C 72.67
RLL | CABLE THHN 12 100% COBRE ROJO VTEG
REF A=45.36 REF B=69.04



**12AWG
100M**

NORMAS: ASTM B566
ISO 9001
600V 90°C/105°C
composición: 100% COBRE



CBL-0745 REF C 72.67
RLL | CABLE THHN 12 100% COBRE AZUL
VTEG
REF A=45.36 REF B=69.04

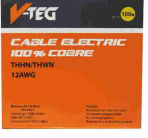

**12AWG
100M**

NORMAS: ASTM B566
ISO 9001
600V 90°C/105°C
composición: 100% COBRE



CBL-0750 REF C 72.67
RLL | CABLE THHN 12 100% COBRE AMARIL
VTEG
REF A=45.36 REF B=69.04



2x18-100M

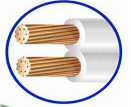

CBL-1220 REF C 27.1
RLL | CABLE SPT 2X18 PARALELO BLANCO
TRIC
REF A=16.92 REF B=25.75



**100M
2x16AWG**



CBL-1225 REF C 28.89
RLL | CABLE SPT 2X16 PARALELO BLANCO
IMP
REF A=18.04 REF B=27.45



**2x20 AWG
100 M**



CBL-2065 REF C 18.94
RLL | CABLE CORNETA 2X20 ROJO/NEGRO
100MT
REF A=11.82 REF B=18



**2x18 AWG
100 M**



CBL-2070 REF C 28.57
RLL | CABLE CORNETA 2X18 ROJO/NEGRO
100MT
REF A=17.84 REF B=27.15

15A



EGL-0050 REF C 1.86
PZA | ADAPTADOR P/TALADRO 15 A
EAG.GRIS 419
REF A=1.16 REF B=1.77



EGL-0250 REF C 4.07
PZA | CLOSTER C/CADENA Y TOMA MARFIL
718
REF A=2.54 REF B=3.87



EGL-0252 REF C 4.07
PZA | CLOSTER C/CADENA Y TOMA
MARRON 718
REF A=2.54 REF B=3.87

2x15A
250V



COOPER

EGL-0463 REF C 5.28
PZA |MACHO 2x15/220V BAK.AMAR HORIZ
4866
REF A=3.29 REF B=5.01



EGL-0625 REF C 5.79
PZA |PROBADOR DE CORRIENTE 2 PATA
914
REF A=3.62 REF B=5.5

4"-1174w



COOPER
EAGLE

EGL-0660 REF C 3.84
PZA |RECEPTACULO S/CAD.4" BLANCO
1174W
REF A=2.4 REF B=3.65

2x20A
125V



COOPER
EAGLE

EGL-0670 REF C 36.83
PZA |TOMA DOB.2x20 125V
HOSP.ROJA.8300RD
REF A=22.99 REF B=34.99

2x15A
125V



COOPER

EGL-0695 REF C 7.75
PZA |TOMA 2x15A 125 C/A MT.P/EXT
POL2887
REF A=4.84 REF B=7.36

2x15A
125V



COOPER

EGL-0719 REF C 5.39
PZA |TOMA 2X15 125V
AER.BAK.POL.AMA.4882
REF A=3.37 REF B=5.12

3x20A
250V



EAGLE

EGL-0730 REF C 9.02
PZA |TOMA P/CAJ 3x20A 250V P/RECTA
805
REF A=5.63 REF B=8.57

2x15A



EAGLE

EGL-0733 REF C 5.06
PZA |TOMA CORRI.AEREA GOMA 2X15A C/
ABZ 178
REF A=3.16 REF B=4.81

3x20A



COOPER

EGL-0734 REF C 25.36
PZA |TOMA CORRI.AEREA META 4X20A C/
ABZ 891
REF A=15.83 REF B=24.1

**3x20A
250V**



COOPER

EGL-0735 REF C 16.23
PZA | TOMA CORRIENTE AEREA 3x20A 250V 895
REF A=10.13 REF B=15.42

15A-125V



EGL-1005 REF C 11.59
PZA | SWIT PUENTE DOBLE 15A 125V 271 (711)
REF A=7.23 REF B=11.01

**10/5 A
125/250V**



COOPER

EGL-1027 REF C 21.69
PZA | SWI/S*3WAY.C/T MET.10/5A 125/250V 984
REF A=13.54 REF B=20.61

**660W
x125V**

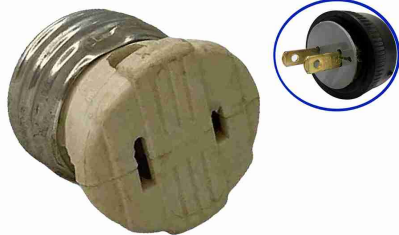

EAGLE

EGL-1210 REF C 1.51
PZA | TAPON TOMA 660W 125V EAGLE 758
REF A=0.94 REF B=1.43



EAGLE

EGL-1252 REF C 1.25
PZA | TAPA TERMOPLA HOSPITAL/ROJA 5132RD
REF A=0.78 REF B=1.19



EAGLE

EGL-1260 REF C 0.89
PZA | TAPA BAKELITA SWITCHE/PUE.MARF 2134
REF A=0.56 REF B=0.85

**2x20A
125V**

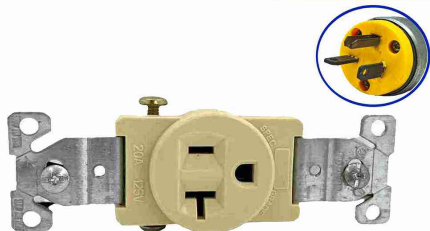

EGL-7327 REF C 6.64
PZA | TOMA P/CAJ SENC.POL.2 X 20A 125V 1877
REF A=4.15 REF B=6.31

**75-300
Ohm**



ELC-0100 REF C 0.32
PZA | ADAPT.75a300 ohm(coax/ para)COCHI.
REF A=0.2 REF B=0.31



**Voltage
electronicsart**

ELC-0110 REF C 0.48
PZA | ADAPTADOR COAXIAL T/ T HEMBRA VOLTG
REF A=0.3 REF B=0.46



8"

CROWNMAN
PROFESSIONAL

ELC-0170 REF C 15.84
PZA |ALICATE PELACABLE TELF-FIBRA
8"CROW
REF A=9.89 REF B=15.05



8"

DIESEL TOOLS

ELC-0175 REF C 11.85
PZA |ALICATE PELACABLE AUTOMAT.8" D-
S205
REF A=7.4 REF B=11.26



Voltage
electronicsPart

ELC-0180 REF C 10.43
PZA |TIMBRE ALARMA C/SENS.MOV.DC9V
TIM03
REF A=6.51 REF B=9.91



ELC-0192 REF C 2.19
PZA |ANTENA DOBLE P/TELEVISOR C/BASE
DOB
REF A=1.37 REF B=2.08



**30-40 A
220V**

CLASSIC
LUX

ELC-0215 REF C 178.98
PZA |ARRANCADOR DIRECTO 30 A 40 AMP
220V
REF A=111.72 REF B=170.04



**48-65 A
220V**

CLASSIC
LUX

ELC-0218 REF C 187.92
PZA |ARRANCADOR DIRECTO 48 A 65 AMP
220V
REF A=117.31 REF B=178.54



**63-80 A
220V**

CLASSIC
LUX

ELC-0221 REF C 201.35
PZA |ARRANCADOR DIRECTO 63 A 80 AMP
220V
REF A=125.69 REF B=191.29



ELC-0250 REF C 0.64
PZA |BENJAMIN TELF TOMA DOBLE HEMBRA
REF A=0.4 REF B=0.6



ELC-0252 REF C 0.87
PZA |BENJAMIN TELF TOMA TRIPLE HEMBRA
REF A=0.54 REF B=0.83



2M



ELC-0770 REF C 0.54
PZA | CABLE UTP CAT 5 2 MTS FC102

REF A=0.33 REF B=0.51



**1.5M-100W
110/220V**

UTIL PARA:
TV, LAPTOP Y RADIO



ELC-0815 REF C 0.83
PZA | CABLE GRABAD+TV 1.5MTS 100W
110/220

REF A=0.52 REF B=0.79



10A-600V



ELC-0850 REF C 8.95
PZA | CAJA BOTONERA 10A VERDE
1PULSA.BA31

REF A=5.59 REF B=8.5



10A-600V



ELC-0852 REF C 8.95
PZA | CAJA BOTONERA 10A ROJO 1
PULSA.BA42

REF A=5.59 REF B=8.5



**22mm
1 HUECOS**



ELC-0860 REF C 3.82
PZA | CAJA BOTONERA PVC 1 HUECO 22MM
IP66

REF A=2.38 REF B=3.62



**22mm
2 HUECOS**



ELC-0861 REF C 4.71
PZA | CAJA BOTONERA PVC 2 HUECO 22MM
IP66

REF A=2.94 REF B=4.47



**22mm
3 HUECOS**



ELC-0862 REF C 5.82
PZA | CAJA BOTONERA PVC 3 HUECO 22MM
IP66

REF A=3.63 REF B=5.53



**22mm
4 HUECOS**



ELC-0863 REF C 7.28
PZA | CAJA BOTONERA PVC 4 HUECO 22MM
IP66

REF A=4.54 REF B=6.91



RG-59

ELC-1010 REF C 0.14
PZA | CONECTOR RG-59 C/ROSC.TWIS-ON
CABL

REF A=0.09 REF B=0.13

F-56

ELC-1015 REF C 0.26
 PZA | CONECTOR RG-6 C/RSC F-56 C/
 DIRECTV
 REF A=0.16 REF B=0.25

RG6

ELC-1020 REF C 0.37
 PZA | CONECTOR RG-6 C/RSC AZUL/
 DIREC.F56
 REF A=0.23 REF B=0.36

F-81

ELC-1050 REF C 0.16
 PZA | CONECT.RG-59<UNION>EMPATE
 CAB.F-81
 REF A=0.1 REF B=0.15

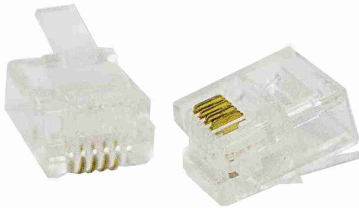
RJ-11

ELC-1090 REF C 3.91
 PQT | CONECT.TRASP.M.4C P/TEL.RJ-11
 PQ100
 REF A=2.44 REF B=3.71

**8C RJ-45
PQ100**

ELC-1100 REF C 8.2
 PQT | CONECT.TRAN.M.8C P/COMP.RJ-45
 PQ100
 REF A=5.12 REF B=7.79

12A-220V

CLASSIC
LUX

ELC-1153 REF C 13.21
 PZA | CONTACTOR 12 AMP 220V LC1-D
 REF A=8.25 REF B=12.55

95A-220V

CLASSIC
LUX

ELC-1177 REF C 73.83
 PZA | CONTACTOR 95 AMP 220V DB-LC1-
 D95M7
 REF A=46.08 REF B=70.14

**115AMP
220V**

CLASSIC
LUX

ELC-1180 REF C 190.16
 PZA | CONTACTOR 115 AMP 220V LC1-D
 REF A=118.7 REF B=180.67

**150A-
220V, LC1-D**

CLASSIC
LUX

ELC-1183 REF C 194.64
 PZA | CONTACTOR 150 AMP 220V LC1-D
 REF A=121.5 REF B=184.92



ELC-2040 REF C 0.28
 PZA | EMPALME P/EXTENCION TELEFONO
 REF A=0.18 REF B=0.27



ELC-2900 REF C 30.5
 PZA | MAGAF.MUSIC/REC/
 PLA.MICR+USB+BAT15W
 REF A=19.04 REF B=28.98



15 A

ELC-2950 REF C 5.65
 PZA | MICRO SWITCHES 15AMP Z-15GD-B DB
 REF A=3.53 REF B=5.37



ELC-3015 REF C 7.87
 PZA | MULTIMET.DIG.AC/DC 600V 10AM
 830B Z
 REF A=4.91 REF B=7.47



ELC-5002 REF C 16.56
 PZA | PINZA METAL.TELF.RED RJ11-RJ45
 2167
 REF A=10.33 REF B=15.73



ELC-5074 REF C 6.26
 PZA | PIL.LED VOLTME.22M AMAR 85/265
 D22
 REF A=3.91 REF B=5.95



ELC-5080 REF C 2.57
 PZA | PILOTO LED 85/265W 22MM ROJO
 AD16
 REF A=1.6 REF B=2.44



ELC-5082 REF C 2.57
 PZA | PILOTO LED 85/265W 22MM VERDE
 AD16
 REF A=1.6 REF B=2.44



ELC-5084 REF C 2.57
 PZA | PILOTO LED 85/265W 22MM
 AMARIL.AD16
 REF A=1.6 REF B=2.44

**110V-22mm
ROJO**



**CLASSIC
LUX**

ELC-5091 REF C 3.37
PZA | PILOTO LED ALARMA 110V 22MM
ROJO
REF A=2.1 REF B=3.2

**220V-22mm
ROJO**



**CLASSIC
LUX**

ELC-5092 REF C 3.37
PZA | PILOTO LED ALARMA 220V 22MM
ROJO
REF A=2.1 REF B=3.2

**110V-22mm
VERDE**



**CLASSIC
LUX**

ELC-5093 REF C 3.37
PZA | PILOTO LED ALARMA 110V 22MM
VERDE
REF A=2.1 REF B=3.2

**22mm
NA+NC, XB2**



ELC-5094 REF C 3.37
PZA | PILOTO LED ALARMA 220V 22MM
VERDE
REF A=2.1 REF B=3.2

**22mm
NA+NC, XB2**



ELC-5100 REF C 2.31
PZA | PULSADOR 22MM NA+NC VERDE XB2-
CLAS
REF A=1.44 REF B=2.19

ELC-5102 REF C 2.31
PZA | PULSADOR 22MM NA+NC ROJO XB2
CLAS
REF A=1.44 REF B=2.19

**10A-22mm
NA+NC, XB4-BA42**



ELC-5104 REF C 6.26
PZA | PULSAD.10A.22MM NA+NC VERD.XB4-
BA31
REF A=3.91 REF B=5.95

**10A-22mm
NA+NC, XB4-BA42**



ELC-5106 REF C 6.26
PZA | PULSAD.10A.22MM NA+NC ROJO XB4-
BA42
REF A=3.91 REF B=5.95

**CLASSIC
LUX**

ELC-5108 REF C 12.98
PZA | PULS.DOBLE 10A.240V XB4BW84M5
VE/RO
REF A=8.1 REF B=12.33





**10Amp
240v**

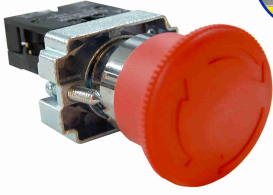

**CLASSIC
LUX**

ELC-5115 REF C 5.25
PZA |PULSA.T/HONGO 10A 22M ROJ.XB2-BS542

REF A=3.28 REF B=4.99



**15A-380V
2.2Kv-3P**



**CLASSIC
LUX**

ELC-5117 REF C 6.71
PZA |PULS.PUSH.ON-OFF 15A 3P TRIF380V216

REF A=4.19 REF B=6.38

**30A-380V
2.2Kv-3P**



**CLASSIC
LUX**

ELC-5118 REF C 8.38
PZA |PULS.PUSH.ON-OFF 30A 3P TRIF380V230

REF A=5.23 REF B=7.96



**460
VOLTIOS**



**MA
Tools**

ELC-5120 REF C 2.27
PZA |PROBAD.(TESTER)AC/DC MULT/VOLT460V

REF A=1.42 REF B=2.16



**220V-MK3P-I
10A-11PINES**



**CLASSIC
LUX**

ELC-5852 REF C 6.71
PZA |RELE 11 PINES 10AMP AC 220V MK3 P-I

REF A=4.19 REF B=6.38



**CLASSIC
LUX**

ELC-5860 REF C 2.03
PZA |RELE BASE P/RELE 11 PINES PF-113A

REF A=1.26 REF B=1.92

**10A-600V
2 POSICIONES**



**CLASSIC
LUX**

ELC-5960 REF C 5.16
PZA |SELE.2 POSC.10A 240V XB2BD21 ON/OFF

REF A=3.22 REF B=4.9

**10A-240V
2 POSICIONES**



**CLASSIC
LUX**

ELC-5964 REF C 6.95
PZA |SELEC.2 POS.10A 240V XB4BD21 ON/OFF

REF A=4.34 REF B=6.6

10A-600V



**CLASSIC
LUX**

ELC-5966 REF C 8.29
PZA |SEL.3 POS.10A 240 XB4BD33 ON/OFF/ON

REF A=5.17 REF B=7.88

5-900 OHM



ELC-6000 REF C 0.62
PZA | SPLITTER 2 VIAS COAX.5A900mhz
MINI
REF A=0.38 REF B=0.58

**3 Vias-5Amp
9000hm**



Voltage
electronics part

ELC-6020 REF C 0.96
PZA | SPLITTER 3 VIAS COAX.5AMP 900 mhz
REF A=0.6 REF B=0.92



ELE-0072 REF C 0.43
PZA | ADAPTADOR TALADRO GRIS T/EAGLE
419
REF A=0.27 REF B=0.41

**15AMP
125V**



ELE-0074 REF C 0.94
BLT | ADAPT.TALADR.15A 125V RADI/UL
1 PAR
REF A=0.59 REF B=0.89

12v - 9Ah



SPTLINE™

ELE-0393 REF C 36.5
PZA | BAT.SEL.ALAR/CERC/PLANT/ELC
12V-9Ah
REF A=22.79 REF B=34.68

5-7W



**CLASSIC
LUX**

ELE-0932 REF C 3.53
PZA | BALASTO DRIVER PANEL LED 5-7W
CLAS
REF A=2.21 REF B=3.36

8-12W



**CLASSIC
LUX**

ELE-0934 REF C 4.36
PZA | BALASTO DRIVER PANEL LED 8-12W
CLAS
REF A=2.72 REF B=4.14

15-18W



**CLASSIC
LUX**

ELE-0936 REF C 5.18
PZA | BALASTO DRIVER PANEL LED 15-18W
CLAS
REF A=3.23 REF B=4.92

21W



**FM
FERMETAL**

ELE-0950 REF C 5.23
PZA | BALASTO ELECT.LAM/MARIPOSA 21W
REF A=3.26 REF B=4.97

38W

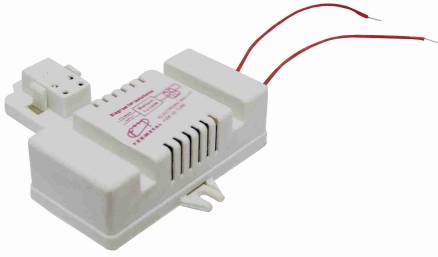

ELE-0952 REF C 5.77
PZA |BALASTO ELECT.LAM/MARIPOSA 38W

REF A=3.6 REF B=5.48

110V-11W

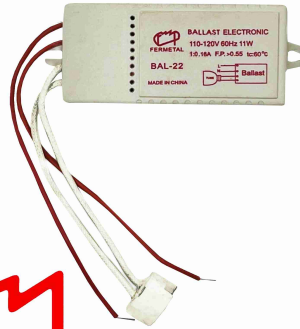

ELE-0955 REF C 1.79
PZA |BALAST/DICROIC.AHOR 110.11W
ILU8200

REF A=1.12 REF B=1.7

**1x22W
110 V**

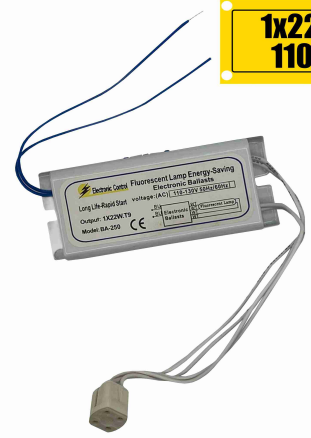

ELE-0972 REF C 4.12
PZA |BALASTO ELECT.1x22W.110 C/SOC FM

REF A=2.57 REF B=3.92

**1x32W
110 V**



ELE-0974 REF C 4
PZA |BALAST.ELEC.1x32W.110V C/SOC FM/
LG

REF A=2.5 REF B=3.8

1x20W



ELE-0992 REF C 4.26
PZA |BALAST.ELECT.1X20W LAM.PLANA
1470/80

REF A=2.66 REF B=4.05

**1x40W
130V**

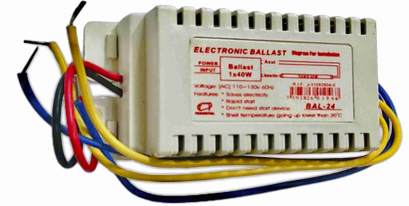

ELE-0998 REF C 3.05
PZA |BALASTO ELECTRONICO 1X40W 130V
FM

REF A=2.96 REF B=3.21

**1x40W
120V**



ELE-1006 REF C 3.53
PZA |BALASTO MAG.1X40 RS-120V LUMIK/
FR-140

REF A=2.21 REF B=3.36

**2x40W
110V**



ELE-1017 REF C 5.6
PZA |BALASTO ELECTRONICO 2x40W 110V
FM

REF A=3.5 REF B=5.32

**2x17A
32W**



ELE-1018 REF C 37.68
PZA |BALA.ELECT.3x17-32W MULTVOL OS/
ADV

REF A=23.52 REF B=35.8

**3x17
20-32-40W**



ELE-1019 REF C 25.01
PZA |BALAS.ELECTR.3x17-20-32-40W 120V YA
REF A=15.61 REF B=23.76

**3x17
110V-130**



ELE-1020 REF C 20.82
PZA |BALASTO ELECTR.3x17-110V-130 FM
REF A=12.99 REF B=19.78

**3x32
110V-130**



ELE-1021 REF C 31.56
PZA |BALASTO ELECTR.3x32-110V-130 FM
REF A=19.7 REF B=29.98

150w-208V

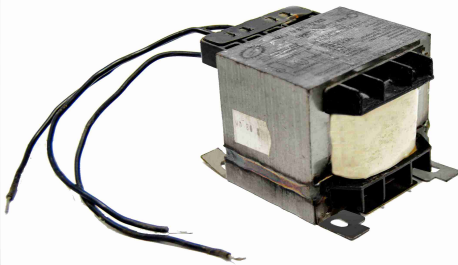

ELE-1042 REF C 20.02
PZA |BALAS.SODIO/METAL.H 150W 208V ELCO
REF A=12.5 REF B=19.02

400w-208V

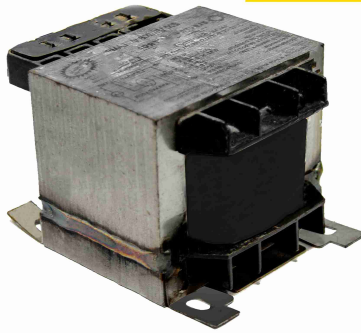

ELE-1046 REF C 43.57
PZA |BALAS.SODIO/METAL.H 400W 208V ELCON
REF A=27.2 REF B=41.39



ELE-1485 REF C 3.37
PZA |BASE P/REFLECTOR SENCILL.PAR38 IMP
REF A=2.1 REF B=3.2



ELE-1490 REF C 5.6
PZA |BASE P/REFLECTOR DOBLE PAR 38 IMP
REF A=3.5 REF B=5.32



ELE-1494 REF C 8.95
PZA |BASE P/REFLECTOR TRIPLE PAR 38 IMP
REF A=5.59 REF B=8.5



ELE-1496 REF C 16.32
PZA |BASE REFLEC.TRIP.C/SENS.150W E27 20
REF A=10.19 REF B=15.5



ELE-1499 REF C 0.59
 PZA | BASE APAGADOR PLASTICO RED.
 PLASVAL
REF A=0.37 REF B=0.56



ELE-1500 REF C 0.59
 PZA | BASE APAGADOR PLASTICA
 RECTANGULAR
REF A=0.37 REF B=0.56

15 A



Voltage
 electronicsart

ELE-1532 REF C 0.64
 PZA | BENJAMIN T/EAGLE GOMA BLANCO
 15AMP
REF A=0.4 REF B=0.61



ELE-1580 REF C 0.78
 PZA | BOTON PVC CIEGA TUERC.P/NIPLE
 CROS
REF A=0.49 REF B=0.74



ELE-1618 REF C 1.04
 PZA | CANALETA ELECT.10X10m ADHE.2mt
 BLA
REF A=0.65 REF B=0.99



ELE-1625 REF C 1.44
 PZA | CANALETA ELECT.15X10m ADHE.2mt
 BLA
REF A=0.9 REF B=1.37



ELE-1630 REF C 1.47
 PZA | CANALT.P/ELEC.20X10m 2mts BLA S/
 PEGA
REF A=0.92 REF B=1.4



ELE-1690 REF C 5.14
 PZA | CANALETA PISO GRIS 35X10X2 MTS
 TRI
REF A=3.21 REF B=4.88



ELE-1692 REF C 6.58
 PZA | CANALETA PISO GRIS 50X15X2 MTS
 TRI
REF A=4.11 REF B=6.25



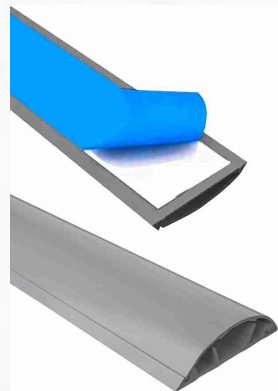

**70x20mm
2 M**



ELE-1694 REF C 10.43
PZA | CANALETA PISO GRIS 70X20X2 MTS TRI
REF A=6.51 REF B=9.91

**2PAR
100MTS**



ELE-1749 REF C 14.81
RLL | CABLE TELFO.2 PAR REDOND.GRIS 100M
REF A=14.16 REF B=15.61

**100 M
3 PARES**

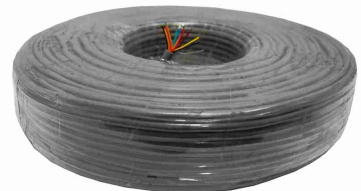

ELE-1755 REF C 29.77
RLL | CABLE TELFO.3 PAR REDOND.GRIS 100M
REF A=18.58 REF B=28.28

**100 M
4 PARES**

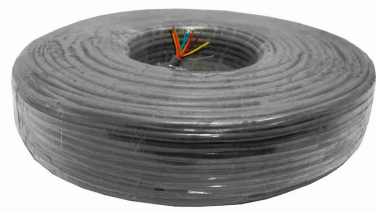

ELE-1756 REF C 17.74
RLL | CABLE TELFO.4 PAR REDOND.GRIS 100M
REF A=73.01 REF B=85.3



**CAT6-70%
305 M**



TRIC

ELE-1762 REF C 98.72
RLL | CABLE UTP CAT6 AZUL 70% 305MT TRIC
REF A=61.62 REF B=93.79

305 M



ELE-1765 REF C 26.4
RLL | CABLE COAXIAL RG-59 BLANC.RL 100MT
REF A=16.48 REF B=25.08

**RG6x
305M**



ELE-1775 REF C 75.07
RLL | CABLE COAXIAL RG-6U BLA.305M VT2361
REF A=46.86 REF B=71.32

TEG

10A-250V



ELE-1830 REF C 0.61
PZA | CONVERTIDOR EUROPEO-AMERICANO 10A 250
REF A=0.38 REF B=0.58

6A-250V



ELE-1831 REF C 0.32
PZA | CONVERTIDOR EUROPEO-AMERIC.6A 250V
REF A=0.2 REF B=0.31

**50-70M2
5 PCS**

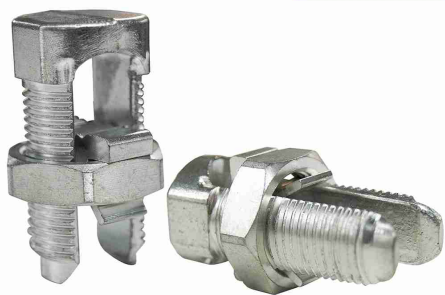

DIESEL TOOLS

ELE-1870 REF C 10.07
PZA | CON.BIM.KSU-25-26 AWG 2-1/0-2/0
70M
REF A=6.28 REF B=9.56

5/8"

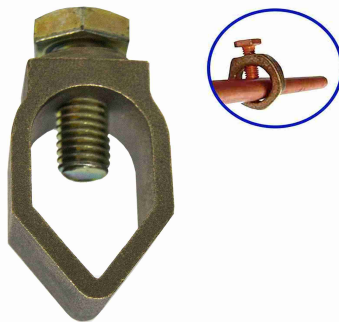

ELE-1890 REF C 2.14
PZA | CONECTOR COBRE P/BARRA
COPPERW.5/8
REF A=1.34 REF B=2.03

**50/60Hz
380V**



ELE-1903 REF C 6.48
PZA | CONDESAD.25MF 380V50/60HZ SUN/
LOR
REF A=4.04 REF B=6.15



ELE-1930 REF C 1.02
PZA | CLOSTER C/CADENA Y TOMA T/EAGL
718
REF A=0.63 REF B=0.97

**1000W
110V**



ELE-1950 REF C 97.97
PZA | COC.ELEC.1.HOR.INFRARROJO 1000W
110
REF A=61.16 REF B=93.08

**2200W
220V**



ELE-1953 REF C 130.63
PZA | COC.ELEC.1 HOR.INFRARROJO 2000W
220
REF A=81.54 REF B=124.1

**1000W
110V**



ELE-1955 REF C 9.35
PZA | COCINA ELECT.1HORNILLA 1000w
110V
REF A=5.83 REF B=8.88

**1000W
110V**



**FM
FERMETAL**

ELE-1957 REF C 17.04
PZA | COCINA ELECT.2HORNILLA 1000W
110V
REF A=10.64 REF B=16.19

**1000W
110V**



**FM
FERMETAL**

ELE-1959 REF C 18.74
PZA | COCIN ELECT.2HORN.C/TAPA
1000W110V
REF A=11.7 REF B=17.8

2P-30A



Voltage
electronicsart

ELE-1970 REF C 3
PZA | CUCHILLA PORCELANA 2X30 AMP S/
FUSB
REF A=1.87 REF B=2.85

2X60 A



ELE-1972 REF C 3.77
PZA | CUCHILLA PORCELANA 2X60 AMP S/
FUSB
REF A=2.35 REF B=3.58

2x100A



ELE-1974 REF C 6.53
PZA | CUCHILLA PORCELAN.2X100 AMP C/
FUSB
REF A=4.07 REF B=6.2

2x30 A



WEQUP
QUALITY PRODUCTS

ELE-1988 REF C 2.49
PZA | CUCHILLA 2 PASE 2 X 30 AMP WQ
REF A=1.55 REF B=2.36

3x60 A



FM
FERMETAL
CLASSIC
LUX

ELE-1993 REF C 9.04
PZA | CUCHILLA 2 PASE 3 X 60 AMP FM
REF A=5.64 REF B=8.59



ELE-2000 REF C 0.78
PZA | SOPORTE P/TUBO CIRCULAR
METALICO
REF A=0.49 REF B=0.74



ELE-2100 REF C 0.78
JGO | CONJUNT.CROS-OVER.PLA/
NIP.TUER.GLZ
REF A=0.49 REF B=0.74

3/8" x2.1/2"



ELE-2200 REF C 0.47
PZA | NIPLE ROSCAD.3/8X2.1/2" P/CONJ
CROS
REF A=0.29 REF B=0.45

1/8" x30M



DIESEL TOOLS

ELE-2661 REF C 23.68
PZA | CINTA PASACABL.P/ELECT.1/8X30MT
104
REF A=14.78 REF B=22.49

3/4"



ELE-2727 REF C 0.94
PZA | CURVA ELECTRIC.NEMA PVC BLANCA 3/4
REF A=0.59 REF B=0.89

1"



ELE-2730 REF C 1.51
PZA | CURVA ELECTRIC.NEMA PVC BLANCA 1"
REF A=0.94 REF B=1.43

1.1/2"



ELE-2732 REF C 3.16
PZA | CURVA ELECTR.NEMA PVC BLANCA 1.1/2
REF A=1.97 REF B=3

2"



ELE-2735 REF C 6.01
PZA | CURVA ELECTRIC.NEMA PVC BLANCA 2"
REF A=3.75 REF B=5.71

3/4"



ELE-2747 REF C 0.42
PZA | CURVA POLIETILENO P/ELECT.DE 3/4"
REF A=0.26 REF B=0.4

1"



ELE-2749 REF C 0.57
PZA | CURVA POLIETILENO P/ELECT.DE 1"
REF A=0.35 REF B=0.54

10"



ELE-3025 REF C 35.31
PZA | EXT.AIR PL.CUA-C/REJ-FRONTAL 10"FM
REF A=22.04 REF B=33.55



**105-305v
1000w**



Troen
ELE-3610 REF C 5.73
PZA | FOTOCELULA 105-305V 1000W S/B VOLTAGE
REF A=3.57 REF B=5.44

**110-220V
1000W**



FISHER PIERCE
ELE-3612 REF C 13.09
PZA | FOTOCEL.110/220V 1000W10A FISHER P
REF A=8.17 REF B=12.44



220V-10A

ELE-3622 REF C 4.39
PZA | FOTOCELULA.85-250V 10AMP C/BASE IMP
REF A=2.74 REF B=4.17



105-287V 1000W



ELE-3624 REF C 10.01
PZA | FOTOCELUL.105/287V 1000W 10AXIL/DB
REF A=6.25 REF B=9.51



105-285v 1800w



ELE-3630 REF C 4.2
PZA | FOT:BASE FOTOCEL.C/B 105-285V 1800W
REF A=2.62 REF B=3.99



2000W 10A 110-240

ELE-3635 REF C 10.9
PZA | FHOTOELECTRIC SENS.2000W 10A 110-240
REF A=6.81 REF B=10.36



#7



ELE-3782 REF C 3.18
PQT | GRAPA CHATA PLAS.P/CABLE SPT N° 7
REF A=1.98 REF B=3.02



#8



ELE-3784 REF C 3.18
PQT | GRAPA CHATA PLAS.P/CABLE SPT N° 8
REF A=1.98 REF B=3.02



#10



ELE-3788 REF C 1.06
PQT | GRAPA CHATA PLAS.P/CABLE SPT N° 10
REF A=0.66 REF B=1.01



#14



ELE-3791 REF C 0.78
PQT | GRAPA CHATA PLAS.P/CABLE SPT N° 14
REF A=0.49 REF B=0.74



#6



ELE-3792 REF C 0.7
PQT | GRAPA REDON.PL.P/CABL.ST/TW N° 6
REF A=0.43 REF B=0.66



#10

ELE-3797 REF C 1.2
PQT |GRAPA REDON.PL.P/CABL ST/TW N510

REF A=0.75 REF B=1.14



#12

ELE-3799 REF C 1.42
PQT |GRAPA REDON.PL.P/CABL ST/TW N512

REF A=0.89 REF B=1.35



#5

ELE-3800 REF C 0.59
PQT |GRAPA REDON.PL.P/CABL ST/TW N5 5

REF A=0.37 REF B=0.56



ELE-3803 REF C 2.6
PQT |GRAPA P/CABL.T/T 100PZ C/CLAVO ROD

REF A=1.62 REF B=2.47



LINTERNA LED 1W D2

ELE-3862 REF C 6.78
PZA |LINTERNA LED 1W D 2 BAT BLISTER FM

REF A=4.23 REF B=6.44



LINTERNA LED 1W D3

ELE-3870 REF C 7.11
PZA |LINTERNA LED 1W DX3 BAT BLISTER FM

REF A=4.44 REF B=6.76



240V, 6-8H RECHARGABLE

ELE-3882 REF C 3.61
PZA |LINTER.RECARGAB.12+1LED 6-8HR N-2 V

REF A=2.25 REF B=3.43



240V, 6-8H RECHARGABLE

ELE-3884 REF C 2.51
PZA |LINTERNA RECARGABLE LED 6-8HR N7 VO

REF A=1.57 REF B=2.39



240V, 6-8H RECHARGABLE

ELE-3888 REF C 3
PZA |LINTERNA RECARGABLE LED 6-8HR N8 VO

REF A=1.87 REF B=2.85

**23W, 6-8H
RECHARGABLE**



Voltage
electronics part

ELE-3891 REF C 8.21
PZA |LINT.RECARG.+SOLAR 24+1 LED 3W
N10
REF A=5.13 REF B=7.8



Voltage
electronics part

ELE-3893 REF C 27.72
PZA |LINT.RECAR.USB LED+SOL+IMAN
3LUZN14
REF A=17.3 REF B=26.33



Voltage
electronics part

ELE-3897 REF C 10.09
PZA |LINT.RECARG.USB+SOLAR LED 180W
N15
REF A=6.3 REF B=9.58

180W



**HALOGENO
3M**



WEQUP
QUALITY PRODUCTS

ELE-3930 REF C 5.58
PZA |LINT.MINI P/CARRO B/HALG B/MANG
3MTS
REF A=3.48 REF B=5.3

2x15A



ELE-4200 REF C 1.08
PZA |MACH.DOMEST.2X15A VINYL S/
ABZ.100
REF A=0.67 REF B=1.02

2x15A



FM
FERMETAL

ELE-4217 REF C 0.89
PZA |MACHO.GOM.2X15A CHAT.NEG T/
E1140FM
REF A=0.56 REF B=0.85

2X15A



ELE-4231 REF C 1.07
PZA |MAC.SEM/IND.2X15 VIN.S/A P/TIE 350
REF A=0.67 REF B=1.02

2x15A



ELE-4235 REF C 1.48
PZA |MACH.SM/IND.2X15 V/P/TIE-C/ABZ
F-31
REF A=0.93 REF B=1.41

**2x15A
125V**



FM
FERMETAL

ELE-4255 REF C 1.04
PZA |MACH.S/IND.2X15 125V GOMA C/
AT/852
REF A=0.65 REF B=0.98

2x15A



ELE-4257 REF C 1.34
PZA |MACH IND.GOM.2X15A 125V
TIP/101EAG
REF A=0.84 REF B=1.28



**2x20A
125V**



ELE-4258 REF C 0.94
PZA |MACH IND.2X20A 125V C/A.AMA P/
T1877
REF A=0.58 REF B=0.89

2x15-125V



ELE-4259 REF C 0.78
PZA |MACH IND.2X15/125V C/
A.MT.AMT/2862
REF A=0.48 REF B=0.74

**2x20A
250v**



ELE-4260 REF C 1.02
PZA |MACH IND.2X20A 250V AMA/
TCR20/1876
REF A=0.63 REF B=0.97

15A-125V



ELE-4261 REF C 0.96
PZA |MACH IN.2X15/125 C/A.C/T MT/
AT2867
REF A=0.6 REF B=0.92

**2x15A
250v**



ELE-4262 REF C 1.23
PZA |MACHO.2x15A/250V C/
A.AM.HORIZ.2866
REF A=0.77 REF B=1.17

**3x20A
125-250v**

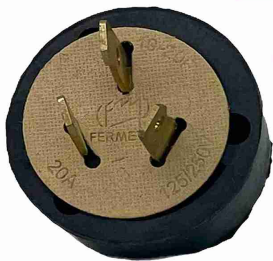

ELE-4263 REF C 2.38
PZA |MACH.3X20AMP 125/250V P/RECTA
GOMA
REF A=1.48 REF B=2.26

**3x50A
125-250v**



ELE-4264 REF C 2.64
PZA |MACH.3X20A 125/250 P/
REC.AMA2836FM
REF A=1.65 REF B=2.51

**2x15A
125v**



ELE-4272 REF C 1.53
PZA |MACH.IND 2X15A/125V AM/VIN P/
T4867
REF A=0.96 REF B=1.45

**4x30A
125-250V**



ELE-4280 REF C 12.32
PZA | MACH IND. 4P x 30A / 250V PLANTA-
GENERAD
REF A=7.69 REF B=11.7

15A-125V



ELE-4605 REF C 5.38
PZA | MULTITOMA C/T. 15A 125 6TOM
PARED-
REF A=3.36 REF B=5.11

15A-125V



ELE-5790 REF C 1.31
PZA | PANELA TRIP. MARF. ECON. 15A/125V
G/F
REF A=0.82 REF B=1.24

3/8"



ELE-5850 REF C 1.74
PZA | PLATINA ROSCADA 3/8 P/NIP. CROS
OVER
REF A=1.09 REF B=1.66

**15A-120V
1800W**



ELE-5882 REF C 9.95
PZA | PROTEC. VOLT. 1T 1800W 15A 120V
T08
REF A=6.21 REF B=9.46

**2400W
120W**



ELE-5883 REF C 39.37
PZA | PROT. AIRE/CAVA. B/B 120V 2400W
20A CL
REF A=24.58 REF B=37.41

20A-220V



ELE-5884 REF C 10.92
PZA | PROT. AIRE/FIL. ENFRI. 1T. 20A 220V
T06
REF A=6.81 REF B=10.37

**20A-120V
REGULABLE**



ELE-5885 REF C 13.7
PZA | PROT. AIRE. AJ. VOLT. 1T. 20A. 120
T11
REF A=8.55 REF B=13.01

20A-220V



ELE-5886 REF C 19.58
PZA | PROT. AIRE/CAV. B/B 36MIL. 20A 220
T13
REF A=12.22 REF B=18.61

**220V-30A
6600W**



**CLASSIC
LUX**

ELE-5887 REF C 43.19
PZA | PROT.AIRE/CAV.B/B 220V 6600W 30A
CL
REF A=26.96 REF B=41.03



ELE-5891 REF C 14.24
PZA | PROTEC.P/ELEC.PC/TV/LAV/MIC/HOR/
COPI
REF A=8.89 REF B=13.53



ELE-5892 REF C 13.7
PZA | PROT.TV/REF/AIR/LAV/120 20A
REG.V88
REF A=8.55 REF B=13.01



**120V-20A
REGULABLE**



V-TEG

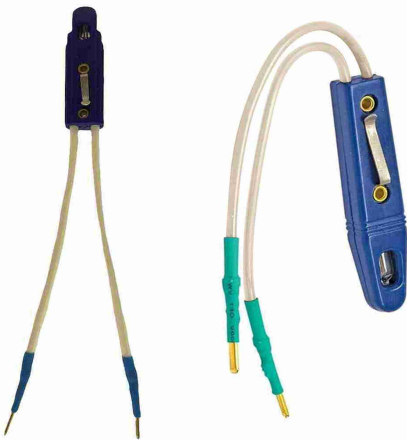

ELE-5985 REF C 1.06
PZA | PROBADOR CORRIENTE 2PAT.T/EAG
914
REF A=1.01 REF B=1.19



V-TEG

ELE-5989 REF C 3.77
PZA | PROB.VOLTAJ.3IN1 110/220/380V
VT546
REF A=2.35 REF B=3.58



**110/220
/380V**



ELE-6001 REF C 0.96
PZA | PROBADOR D/CORRIEN.T/
DEST.100-500V
REF A=0.6 REF B=0.92

100-500v



ELE-6003 REF C 0.71
PZA | TOMA SENCILLO PORCELANA CHINA
REF A=0.44 REF B=0.67



V-TEG

ELE-6070 REF C 0.78
PZA | RECEPT.BAKELT.4"150W 250V E-27
VOLT
REF A=0.48 REF B=0.74



**110-220
380**



**F M
FERMETAL**

ELE-6072 REF C 1.12
PZA | RECEPTAC.T/TIC.MOD/OVAL BLANC
406W
REF A=0.7 REF B=1.07



Voltage
electronicsart

ELE-6089 REF C 1.2
PZA | RECEPTACUL.PORCELAN.E-27
4.1/2"VOLT
REF A=0.75 REF B=1.14

100w
80-265v

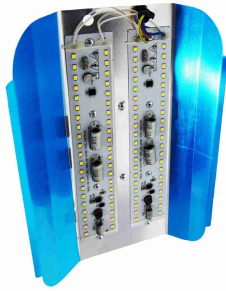

ELE-6091 REF C 13.22
PZA | REFLE.LED ULT/LIV.100W 85-265V
6500
REF A=8.25 REF B=12.56

150w



ELE-6094 REF C 3.37
PZA | REFLECTOR HALOG.150W C/TUB
BLANC I
REF A=2.1 REF B=3.2



500w

ELE-6095 REF C 7.06
PZA | REFLECTOR HALOGE.500W C/TUB
NEG.IM
REF A=4.41 REF B=6.71



500w

ELE-6097 REF C 37.77
PZA | REFLEC.HALG.INYECT.500W S/
TUB.LEGA
REF A=23.58 REF B=35.89



500w

ELE-6098 REF C 3.49
PZA | REF.HLG.INY.500W:VIDRIO REPUST
LEGA
REF A=2.18 REF B=3.31



150w

ELE-6102 REF C 5.65
PZA | REFLECTOR HALOGE.150W C/TUB
NEG.IM
REF A=3.53 REF B=5.37



150w

ELE-6103 REF C 17.5
PZA | REFLECTOR HALOG.150W C/
SENSO.MOVIM
REF A=10.92 REF B=16.62



500w

ELE-6105 REF C 25.9
PZA | REFLECTOR HALOG.500W C/SENSOR
MOV
REF A=16.17 REF B=24.61

1000w



ELE-6106 REF C 8.48
PZA | REFLECTOR HALOGENO 1000W S/TUB
IMP
REF A=5.29 REF B=8.05

1500w



ELE-6111 REF C 22.89
PZA | REFLECTOR HALOGENO 1500W C/TUB
NEG
REF A=14.29 REF B=21.75

**7w-6000k
110-220v**



ELE-6115 REF C 9.18
PZA | REFLECTOR LED 7 W 110-220V 6000K
C
REF A=5.73 REF B=8.73

**10w-6000k
110-220v**



ELE-6117 REF C 13.78
PZA | REFLECTOR LED 10W 110-220V
6000K F
REF A=8.6 REF B=13.09

**20w-6500k
110-220v**



ELE-6121 REF C 23.08
PZA | REFLECTOR LED 20W 110-220V
6500K C
REF A=14.41 REF B=21.93

**80w-6000k
110-220v**



ELE-6122 REF C 58.03
PZA | REFLECTOR LED 80W 110-220V
6000K F
REF A=36.22 REF B=55.13

**100w
6500k**



ELE-6123 REF C 18.94
PZA | REFLECT.LED 100W 100-265 6500K
VT53
REF A=11.82 REF B=18

**150w
6500k**



ELE-6124 REF C 25.26
PZA | REFLECT.LED 150W 100/265 6500K
VT54
REF A=15.76 REF B=23.99

**C10-10A
6mm-380V**



ELE-6129 REF C 18.98
PQT | REGL.ELECT.6MM C-10 380V 10A
PQT10P
REF A=11.85 REF B=18.03

**CLASSIC
LUX**

C8-15A
8mm-380V



CLASSIC
LUX

ELE-6131 REF C **24.14**
PQT |REGL.ELECT.10MM C-8 380V 15A
PQT10P
REF A=**15.07** REF B=**22.93**

C4-60A
25mm-380V



CLASSIC
LUX

ELE-6136 REF C **52.52**
PQT |REGL.ELECT.25MM C-4 380V.60A
PQT10P
REF A=**32.78** REF B=**49.89**

3 PASES
100V



CLASSIC
LUX

ELE-6171 REF C **111.86**
PZA |SECTOR 3 POSICIONES 3P 100AMP
CLS
REF A=**69.83** REF B=**106.27**

4 PASES
100V



CLASSIC
LUX

ELE-6185 REF C **129.76**
PZA |SECTOR 3 POSICIONES 4P 100AMP
CLS
REF A=**81** REF B=**123.28**

6A-125V
2 PINES



ELE-6200 REF C **2.05**
PZA |SWITCH RABITO 6A 125V 2PINE C/C
452
REF A=**1.28** REF B=**1.95**

30A-4PINES
110-250V



ELE-6214 REF C **0.9**
PZA |SWITCH ROCKER 30 AMP 110/250V
4PIN
REF A=**0.56** REF B=**0.85**

4x4



ELE-6294 REF C **0.92**
PZA |TAPA PLAS.CIEGA PES.4X4
CUADR.BLANC
REF A=**0.57** REF B=**0.87**

2x4"



ELE-6295 REF C **0.35**
PZA |TAPA PLAS.CIEG 2X4 C/B MARF.C/T FE
REF A=**0.22** REF B=**0.33**

2x4"

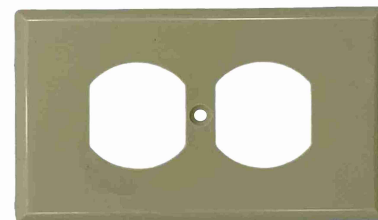

ELE-6298 REF C **0.24**
PZA |TAPA PLAS.DOB 270.C/B MARF.C/T
FEX
REF A=**0.15** REF B=**0.23**

3x50



ELE-6299 REF C 2.73
PZA |TAPA D/TOMA 3X50.INOXIDABLE C/
TORN.
REF A=1.71 REF B=2.6

2x4"

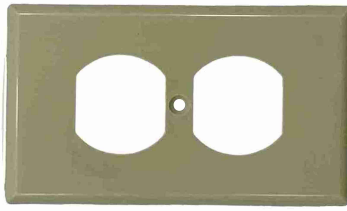

ELE-6300 REF C 0.21
PZA |TAPA PLAS.P/TOMA 270 MARF.C/
TOR.31Z
REF A=0.13 REF B=0.2

Voltage
electronics part

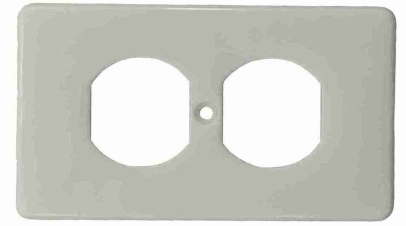

ELE-6301 REF C 0.28
PZA |TAPA PLASTICA P/TOMA 270 BLAN.C/
TO
REF A=0.18 REF B=0.27

2x4"



ELE-6304 REF C 0.57
PZA |TAPA PLASTICA CIEGA 2X4 MARFIL C/
B
REF A=0.35 REF B=0.54



ELE-6305 REF C 0.46
PZA |TAPA PLASTI.SWICHE PUENTE MARF.C/
B
REF A=0.29 REF B=0.44

2x4"



ELE-6307 REF C 2.73
PZA |TAPA DE SWICHE INOXIDABLE C/
TORN.
REF A=1.71 REF B=2.6

15 A



ELE-6320 REF C 1.88
PZA |TOMA AEREA VINYL 15A S/
ABRAZAD.401
REF A=1.18 REF B=1.79

15 A



FM
FERMETAL

ELE-6322 REF C 1.13
PZA |TOMA GOMA AERE.15A S/A T/EAG
180FM
REF A=0.71 REF B=1.07

2x15



ELE-6332 REF C 0.96
PZA |TOMA AEREA 2X15 125 C/A T/EAG
2882
REF A=0.6 REF B=0.92



**2x15A
125V**

ELE-6344

REF C 1.48

PZA | TOMA AER.2X15 125 AMA/PLR T/
VN4882

REF A=0.93

REF B=1.41



**2x15A
125V**

ZTRIC
CLASSIC
LUX

ELE-6345

REF C 0.99

PZA | TOM AER.2X15 125 C/A C/T MT/
AT2887

REF A=0.62

REF B=0.94



**2x15A
125V**

ELE-6346

REF C 1.51

PZA | TOMA AER.2X15 125 AM.P/T.T/4887
FM

REF A=0.94

REF B=1.43



3x20A

FM
FERMETAL

ELE-6349

REF C 4.14

PZA | TOMA AEREA GOMA 3 X 20 AMP
110/130V

REF A=2.59

REF B=3.94



3x50

FM
FERMETAL
CLASSIC
LUX
ZTRIC
Voltage
electronics part

ELE-6352

REF C 2.54

PZA | TOMA P/EMBT.3X50 T/EAG M/32
DB/FM

REF A=1.59

REF B=2.41



**3X50A
125-250V**

ZTRIC
V-TEG

ELE-6354

REF C 4.9

PZA | TOMA SUPERF.3X50A 125-250V T/E
112

REF A=3.06

REF B=4.65

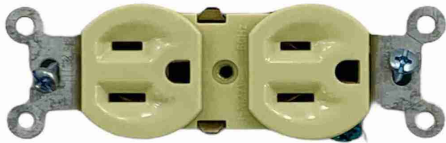

**2x15A
125V**

FM
FERMETAL

ELE-6370

REF C 0.6

PZA | TOMA DOBLE 2x15A 125V.MARF 270
POW

REF A=0.38

REF B=0.57



**2x15A
125V**

Voltage
electronics part

ELE-6371

REF C 0.55

PZA | TOMA DOBLE 2x15A 125V BLAN 270
POW

REF A=0.34

REF B=0.52



**2x15A
125V**

CLASSIC
LUX

FM
FERMETAL **ZTRIC**

ELE-6376

REF C 0.96

PZA | TOMA DOBL 2x15/125 SUP.C/TI.T/E
78

REF A=0.6

REF B=0.92

30 A

CLASSIC
LUX

ELE-6407 REF C 12.08
PZA | TOMA PLANT ELECTRIC.GENERADOR
30AMP
REF A=7.54 REF B=11.48

50 A

CLASSIC
LUX

ELE-6408 REF C 13.66
PZA | TOMA PLANTA ELECTRIC.GENERADO
50AMP
REF A=8.53 REF B=12.98

**15A
125/250V**

V-TEG

ELE-6420 REF C 3.91
PZA | TOMA DOBLE 15A 125/250V+TAPA
PROTEC
REF A=2.44 REF B=3.71

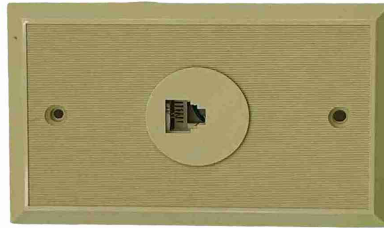

ELE-6490 REF C 4.05
PZA | TOMA TV COAXIAL.P/CAJ SENCILLA
REF A=2.53 REF B=3.85

6P/4C

ELE-6500 REF C 1.6
PZA | TOMA TELF.P/CAJ SENCILL.DIG.6P/4C
REF A=1 REF B=1.52

6P/4C

ELE-6510 REF C 1.6
PZA | TOMA TELF.P/CAJ DOBLE DIG.6P/4C
REF A=1 REF B=1.52

6P/4C

ELE-6530 REF C 0.61
PZA | TOMA TELF.SUPE.SEN.DIG.C/
PEG.6P/4C
REF A=0.38 REF B=0.58

6P/4C

ELE-6532 REF C 0.71
PZA | TOMA TELF.SUPER.DOUBLE.C/
PEG.6P/4C
REF A=0.44 REF B=0.67

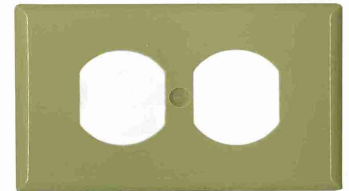
2x4"

WEQUP
QUALITY PRODUCTS

ELE-6554 REF C 0.21
PZA | TAPA BAKL.DOBL MARF.T/EAG 270C/
TOR
REF A=0.13 REF B=0.2

2x4"



ELE-6556 REF C 0.45
PZA | TAPA BAKL.INTR/PUEN T/EAGL MARF FM
REF A=0.28 REF B=0.43

2x4"

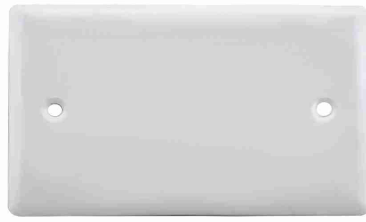

ELE-6557 REF C 0.3
PZA | TAPA PLAS.CIEG 2 X 4 C/B BLAN.C/T89
REF A=0.19 REF B=0.28

3x20

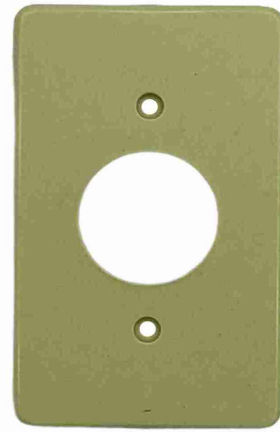

ELE-6560 REF C 0.44
PZA | TAPA PLAS.TOMA 3 X 20 C/B MARF.C/T
REF A=0.28 REF B=0.42

3x20

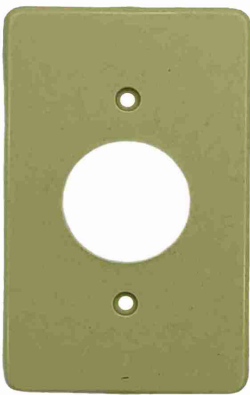

ELE-6563 REF C 0.52
PZA | TAPA PLAS.TOM.3X20C/B MARF.C/T FEX
REF A=0.32 REF B=0.49

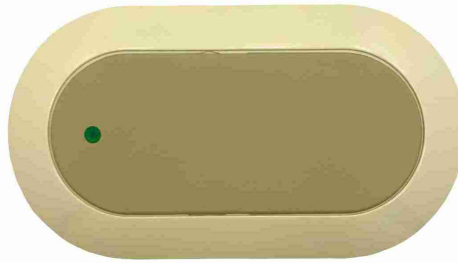

ELE-6567 REF C 0.52
PZA | TAPA CIEGA BEIGE/MARFIL T/NUVA TIC
REF A=0.32 REF B=0.49

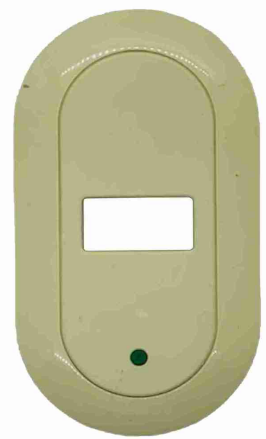

ELE-6572 REF C 0.16
PZA | TAPA SENCILLA MARFIL T/NUVA TIC
REF A=0.1 REF B=0.15



ELE-6574 REF C 0.16
PZA | TAPA TRIPLE MARFIL T/NUVA TIC
REF A=0.1 REF B=0.15



ELE-6576 REF C 0.16
PZA | TAPA CIEGA MADERA T/NUVA TIC FM
REF A=0.1 REF B=0.15

10"



ELE-6602 REF C 34.15
PZA | TIMBRE METALICO CAMPANA 10"IMP
REF A=21.32 REF B=32.44

110V**CLASSIC LUX****ELE-6620 REF C 14.88**
PZA | TIMBRE MUSICAL MELODIA 110V DN

REF A=9.29 REF B=14.14

110V**V-TEG****ELE-6621 REF C 3.93**
PZA | TIMBRE MUSICAL BISON VTEG 110V

REF A=2.45 REF B=3.74

110V**CLASSIC LUX****ELE-6622 REF C 13.28**
PZA | TIMBRE MUSICAL DINBEL ARMONIC 110V

REF A=8.29 REF B=12.62

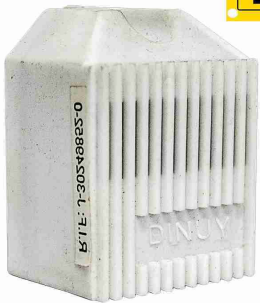
110V**CLASSIC LUX****ELE-6624 REF C 4.59**
PZA | TIMBRE MUSIC. CHICARA DINBEL 110V

REF A=2.87 REF B=4.36

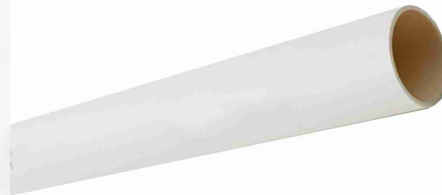
1/2x3M**ELE-7019 REF C 4.1**
PZA | TUBO ELECT. PVC NEMA BLANC. 1/2X3mts

REF A=2.56 REF B=3.89

3/4x3M**ELE-7020 REF C 5.23**
PZA | TUBO ELECT. PVC NEMA BLANC. 3/4X3mts

REF A=3.26 REF B=4.97

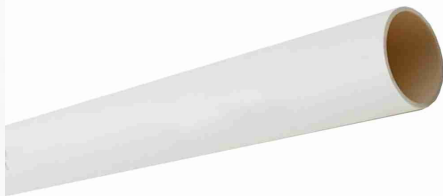
1"x3M**ELE-7021 REF C 6.95**
PZA | TUBO ELECT. PVC NEMA BLANC. 1" X 3mts

REF A=4.34 REF B=6.6

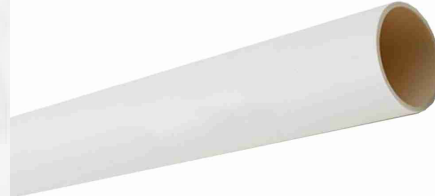
1.1/2x3M**ELE-7022 REF C 13.82**
PZA | TUBO ELECT. PVC NEMA BLANC 1.1/2X3mt

REF A=8.63 REF B=13.13

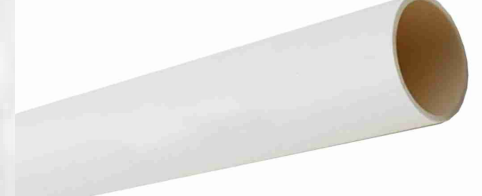
2"x3M**ELE-7023 REF C 19.57**
PZA | TUBO ELECT. PVC NEMA BLANCA 2" X 3mts

REF A=12.22 REF B=18.59

1/2"



ELE-7026 REF C 1.18
PZA |TUBO P/ELECT.POLIETILENO 1/2"

REF A=0.74 REF B=1.12

3/4"



ELE-7039 REF C 1.41
PZA |TUBO P/ELECT.POLIETILENO 3/4"

REF A=0.88 REF B=1.34

1"



ELE-7048 REF C 1.77
PZA |TUBO P/ELECT.POLIETILENO 1"

REF A=1.1 REF B=1.68

10 A



ELE-7066 REF C 3.25
PZA |INTERRUPTOR SENC.TRIWAY 10AM
NASRI

REF A=2.03 REF B=3.09

10 A



ELE-7067 REF C 2.68
PZA |INTERRUPTOR DOBLE 10AMP NASRI FM

REF A=2.56 REF B=2.83

10 A



ELE-7068 REF C 5.4
PZA |INTERRUPTOR TRIPLE 10AMP NASRI FM

REF A=3.37 REF B=5.13



ELE-7070 REF C 2.42
PZA |INTERRUP.PULSADOR TIBRE NASR 96

REF A=1.51 REF B=2.3

**500W
110V**



ELE-7071 REF C 8.88
PZA |INTERRU: DIMER 500W 110V NASRI FM

REF A=5.54 REF B=8.44



ELE-7072 REF C 3.05
PZA |INTERRUPTOR+TOMA UNIV.NASRI
I-101

REF A=1.9 REF B=2.89

T-59



ELE-7075 REF C 2.54
PZA | TOMA SENCILLA UNIVERS.NASRI T-59

REF A=1.58 REF B=2.41

15 A



ELE-7077 REF C 4.43
PZA | TOMA UNIVERSAL DOBL.15AMP NASRI FM

REF A=2.76 REF B=4.21



ELE-7081 REF C 0.47
PZA | TOMA CORRIENTE SUPERFIC.UNIVER.IMP

REF A=0.29 REF B=0.45

**70/400W
220/240**



ELE-7085 REF C 5.3
PZA |IGNITO.70/400W 220/240 MAX 5A SUNL

REF A=3.31 REF B=5.03

10A-250v



ELE-7092 REF C 0.45
PZA |INTER.SUPER.PULSAD.OVAL 10A 250VFM

REF A=0.28 REF B=0.43

T/62



ELE-7100 REF C 0.68
PZA |INTERRUPTO.AEREO T/PERA-62 PLA.IMP

REF A=0.43 REF B=0.65

**15A
125 T**



ELE-7114 REF C 0.75
PZA |INTER.SEN.15A 125 T/EG 1301 BLA SP

REF A=0.47 REF B=0.71

**15A
125 T**



ELE-7115 REF C 0.78
PZA |INTER.SEN.15A 125 T/EG 1301 MARF F

REF A=0.48 REF B=0.74

10A 120 T



ELE-7120 REF C 1.04
PZA |INTERRUPT.DOUBLE P/E.10A 120 T/E 711

REF A=0.65 REF B=0.98

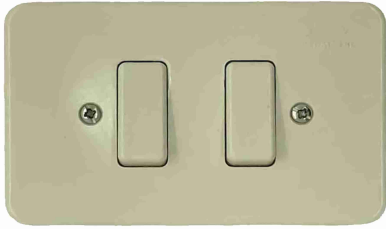

ELE-7184 REF C 2.27
 PZA | INTERRUPTOR DOBL.T/TIC.P/EMP
 POWER
REF A=1.42 REF B=2.16

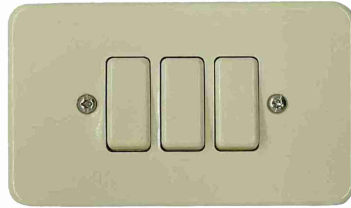

ELE-7186 REF C 2.17
 PZA | INTERRUPTOR TRIPL T/TIC.P/EMP FMX
REF A=1.35 REF B=2.06

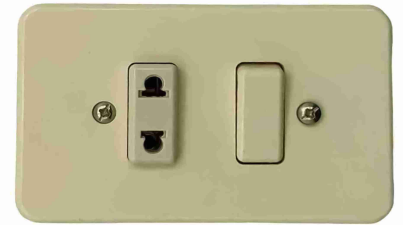

ELE-7188 REF C 1.9
 PZA | INTERRUPTOR+TOMA T/TIC.P/EMP
 POWER
REF A=1.19 REF B=1.8



ELE-7190 REF C 0.86
 PZA | INTERUP/PULSADOR T/TIC P/EMP SP/
 FM
REF A=0.59 REF B=0.81



ELE-7191 REF C 1.81
 PZA | TOMA AMERICA.SENCIL.T/TIC P/EMP
 SP
REF A=1.13 REF B=1.72



ELE-7192 REF C 1.44
 PZA | TOMA UNIVER.DOBL.T/TIC P/EMP
 POWER
REF A=0.9 REF B=1.37

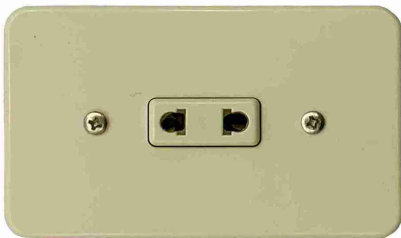

ELE-7193 REF C 1.25
 PZA | TOMA UNIVERSAL.SENC.T/TIC P/EMP
 WQ
REF A=0.78 REF B=1.19



ELE-7196 REF C 0.75
 PZA | TOMA TELEFONO 110V T/TIC BAK
 1182FM
REF A=0.47 REF B=0.72

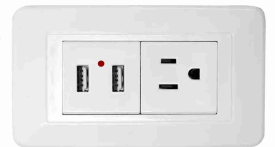

ELE-7197 REF C 6.15
 PZA | TOMA SENC.POLO-T+POLARZ+2USB
 VOLFP2
REF A=3.84 REF B=5.85

56"x5V



CLASSIC LUX

ELE-8100 REF C 70.48
PZA |VENTILAD.TECHO 56"C/CONT 5V
BLUE CR

REF A=44 REF B=66.96

500W-110V

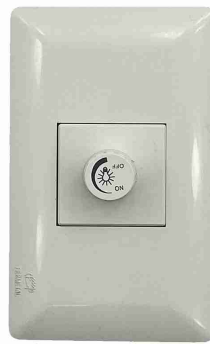

FM FERMETAL

ELG-0400 REF C 9.64
PZA |DIMMER 500W 110V AGENE FM

REF A=9.35 REF B=10.16

**10/15A
110/250V**



V-TEG

ELG-0703 REF C 2.11
PZA |INTERRUPT.SENCIL.GRIS 10AMP VTEG
04

REF A=1.32 REF B=2.01

**110/250V
10/15A**

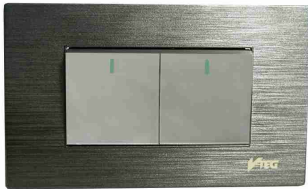

V-TEG

ELG-0713 REF C 2.94
PZA |INTERRUP.DOBLE GRIS 10 AMP VTEG
05

REF A=1.84 REF B=2.8

10 A



FM FERMETAL

ELG-0715 REF C 3.64
PZA |INTERRUPTOR TRIPLE 10 AMP AGENE

REF A=2.28 REF B=3.46

**110/250V
10/15A**

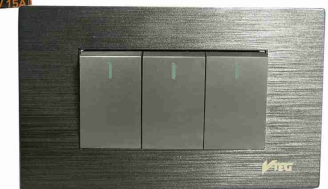

V-TEG

ELG-0717 REF C 3.91
PZA |INTERRUPT.TRIPLE GRIS 10AMP VTEG
06

REF A=2.44 REF B=3.71

10-250V



V-TEG

ELG-0720 REF C 2.22
PZA |INTERRUP.+TOMA
AMER.POLARIZ.AGENE

REF A=1.39 REF B=2.11



FM FERMETAL

ELG-0725 REF C 2.47
PZA |INTERRUP.+TOMA UNIVERSAL.AGENE

REF A=1.54 REF B=2.35



ELG-0733 REF C 2.78
 PZA |INTER.PULSADOR TIMBRE GRIS VTEG
 03
REF A=1.74 REF B=2.64

10 A

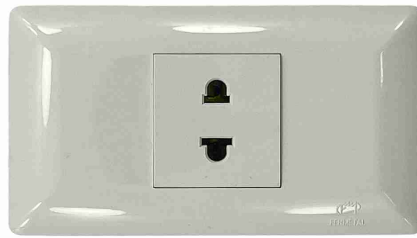

ELG-2000 REF C 1.89
 PZA |TOMA SENC.UNIVERSAL 10 AMP
 AGENE
REF A=1.18 REF B=1.8

10 A



ELG-2005 REF C 3.78
 PZA |TOMA DOBLE.UNIVERSAL 10 AMP
 AGENE
REF A=2.36 REF B=3.59

10 A

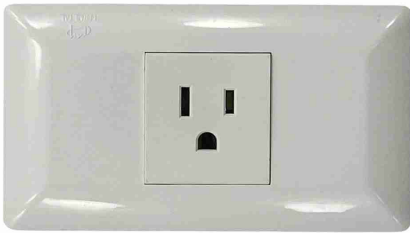

ELG-2010 REF C 2.86
 PZA |TOMA SENC.AMER.POLARZ 10 AMP
 AGENE
REF A=1.79 REF B=2.72

**110/250V
10/15A**



ELG-2017 REF C 8.48
 PZA |TOM DOB.AMER.15A GRI+USB POL.C/
 PT24
REF A=5.29 REF B=8.06

**110/250V
10/15A**



ELG-2022 REF C 2.46
 PZA |TOM DOB.AMER.GRIS 15A POL.C/
 PTIE.08
REF A=1.54 REF B=2.34

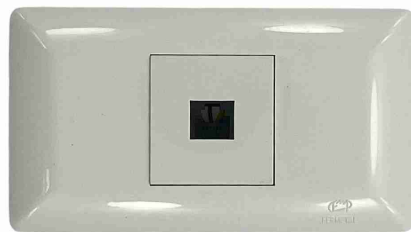

ELG-2025 REF C 2.86
 PZA |TOMA TELEFONO SENCILLA AGENE
REF A=1.79 REF B=2.72

10 A



ELG-3025 REF C 3.25
 PZA |INTERRU.SENC.3VIA 10AMP 110V
 FANCY
REF A=2.03 REF B=3.09



ELG-3050 REF C 3.18
 PZA |INTERRUPTOR PULSADOR FANCY FM
REF A=1.99 REF B=3.02

110V

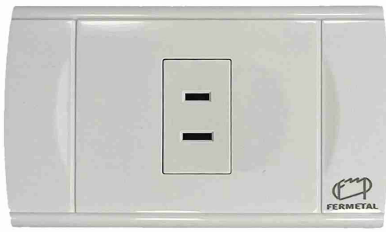

ELG-4040 REF C 2.86
PZA | TOMA SENCILLA AMERIC 110V
ELEGANC
REF A=1.79 REF B=2.72

110V



ELG-4050 REF C 4.11
PZA | TOMA DOBLE UNIVERSAL 110V
ELEGANC
REF A=2.56 REF B=3.9

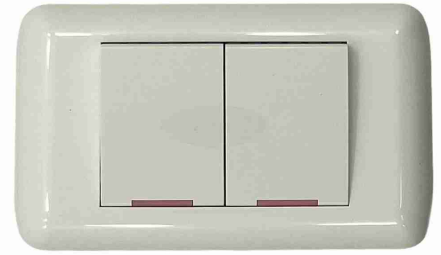

ELL-0010 REF C 4.47
PZA | 5220 INTERRU.P/DOBL LUZ TEST DLUX
CL
REF A=2.79 REF B=4.25

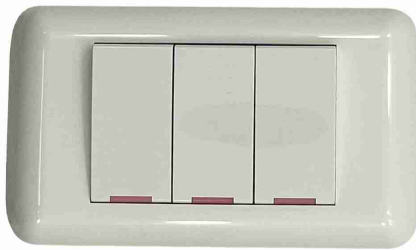

ELL-0015 REF C 5.37
PZA | 5330 INTERRU.TRIPL LUZ TES DLUX
CL
REF A=3.35 REF B=5.1



ELL-0070 REF C 3.82
PZA | 5213 TOMA SENC.AMERIC.P/
TIER.DLUX C
REF A=2.38 REF B=3.62

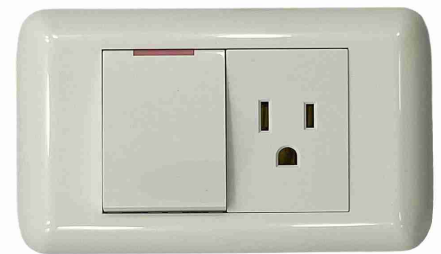

ELL-0120 REF C 4.47
PZA | 5123 TOMA AMER.P/TIER.+INTER.L/T
DL
REF A=2.79 REF B=4.25

**300w
120v**



ELL-0160 REF C 8.29
PZA | 5355 DIMER ROTATIVO 300W 120V
DLUX
REF A=5.17 REF B=7.88

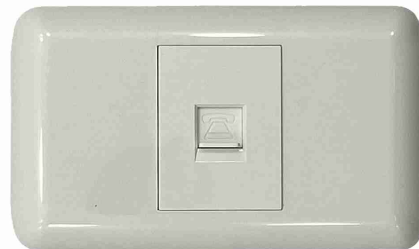

ELL-0170 REF C 4.47
PZA | 5511 TOMA TELEF.SENCILLA DELUXE
CLS
REF A=2.79 REF B=4.25



ELL-0190 REF C 4.47
PZA | 5521 TOMA COAXIAL TV LUZ TES
DLUX C
REF A=2.79 REF B=4.25

RJ-45

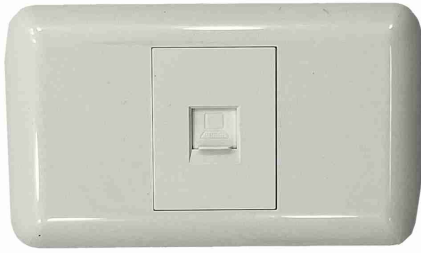

CLASSIC LUX

ELL-0195 REF C 4.47
PZA | 5512 TOMA DATOS INTERNET RJ-45 DLUX
REF A=2.79 REF B=4.25



CLASSIC LUX

ELL-0325 REF C 2.47
PZA | 5000 TAPA CIEGA DELUXE CLASS
REF A=1.54 REF B=2.35

T/TIC 5001



FM FERMETAL

ELL-0370 REF C 0.62
PZA | INTERRUPTO.TACO P/EMBT.T/TIC 5001
REF A=0.59 REF B=0.65

T/TIC 5024



FM FERMETAL

ELL-0390 REF C 1.32
PZA | TOMA UNIVERS.TACO P/E.POL T/ T.5024
REF A=0.82 REF B=1.25



FM FERMETAL

ELL-0397 REF C 0.16
PZA | TOMA TELEFONO TACO FM
REF A=0.1 REF B=0.15

1 PATA, 1"



EMT-0020 REF C 0.19
PZA | ABRAZADERA EMT LIVIANA 1 PATA 1
"
REF A=0.12 REF B=0.18

1 PATA, 3"



EMT-0032 REF C 5.51
PZA | ABRAZADERA EMT 1 PATA 3 "
REF A=3.44 REF B=5.24

1 PATA, 4"



EMT-0034 REF C 8.93
PZA | ABRAZADERA EMT 1 PATA 4 "
REF A=5.57 REF B=8.48

1 PATA, 3/4"



EMT-0042 REF C 0.26
PZA | ABRAZADERA EMT PESADA.1 PATA 3/4"
REF A=0.16 REF B=0.25

1 PATA, 1"



EMT-0044 REF C 0.4
PZA |ABRAZADERA EMT LIVIANA 1 PATA 1"

REF A=0.25 REF B=0.38

2 PATAS, 1"

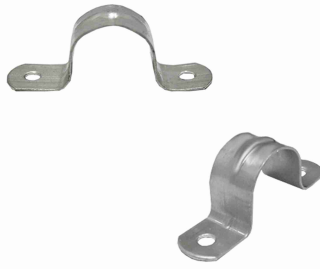

EMT-0064 REF C 0.49
PZA |ABRAZADERA EMT 2 PATA 1"

REF A=0.31 REF B=0.47

2 PATAS, 3"



EMT-0070 REF C 6.59
PZA |ABRAZADERA EMT 2 PATA 3 "

REF A=4.12 REF B=6.26

2 PATAS, 4"



EMT-0072 REF C 8.62
PZA |ABRAZADERA EMT 2 PATA 4 "

REF A=5.38 REF B=8.19

1/2"



EMT-0180 REF C 0.21
PZA |ANILLO CONDUIT PVC 1/2

REF A=0.13 REF B=0.2

3/4"



EMT-0184 REF C 0.68
PZA |ANILLO CONDUIT PVC 3/4

REF A=0.43 REF B=0.65

1"



EMT-0186 REF C 0.59
PZA |ANILLO CONDUIT PVC 1"

REF A=0.37 REF B=0.56

1/2"



EMT-0215 REF C 0.45
PZA |ANILLO EMT ALUMINIO 1/2"

REF A=0.28 REF B=0.43

3/4"



EMT-0217 REF C 0.68
PZA |ANILLO EMT ALUMINIO 3/4"

REF A=0.43 REF B=0.65

1"



EMT-0219 REF C 1.48
PZA | ANILLO EMT ALUMINIO 1"

REF A=0.93 REF B=1.41

1.1/2"



EMT-0221 REF C 3.53
PZA | ANILLO EMT ALUMINIO 1.1/2"

REF A=2.21 REF B=3.36

2"



EMT-0224 REF C 4.29
PZA | ANILLO EMT ALUMINIO 2"

REF A=2.68 REF B=4.07

3"



EMT-0227 REF C 9.09
PZA | ANILLO EMT ALUMINIO 3"

REF A=5.67 REF B=8.64

4"



EMT-0230 REF C 11.7
PZA | ANILLO EMT ALUMINIO 4"

REF A=7.31 REF B=11.12

**1mm
2x4x1/2"**



EMT-0670 REF C 0.73
PZA | CAJETIN MET.CAL.1MM 2X4 X1/2
PESADO

REF A=0.46 REF B=0.69

2x4x1/2"



EMT-0672 REF C 1.98
PZA | CAJETIN METAL ECON.2X4 1/2"CIMCA

REF A=1.23 REF B=1.88

2x4x3/4"



EMT-0677 REF C 1.98
PZA | CAJETIN METAL ECON.2 X 4
3/4"CIMCA

REF A=1.23 REF B=1.88

**4"x1/2"
x3/4"**



EMT-0695 REF C 2.24
PZA | CAJETIN METAL
LIV.OCTOG.4"X1/2-3/4I

REF A=1.4 REF B=2.13

**2x4
1/2x3/4**



EMT-0698 REF C 1.98
PZA |CAJETIN METAL LIV. 2X4 1/2X3/4 IMP
REF A=1.23 REF B=1.88

**1mm
4x1/2x3/4**



EMT-0700 REF C 0.97
PZA |CAJETIN MET.CAL.1M
OCT.4x1/2x3/4PES
REF A=0.6 REF B=0.92

4x1/2"



EMT-0702 REF C 2.24
PZA |CAJETIN METAL ECON.OCTOG
4X1/2"IMP
REF A=1.4 REF B=2.13

4x3/4"



EMT-0707 REF C 2.24
PZA |CAJETIN METAL ECON.OCTOG
4X3/4"IMP
REF A=1.4 REF B=2.13

**4x4
1/2x3/4**



EMT-0757 REF C 2.73
PZA |CAJETIN METAL LIV.CUAD
4X4X1/2x3/4
REF A=1.71 REF B=2.6

5x5x1



EMT-0761 REF C 6.12
PZA |CAJETIN METAL PES.CUADRAD.5 X 5 X
1
REF A=3.82 REF B=5.82

**4x1/2
x3/4**



EMT-0784 REF C 0.35
PZA |CAJETIN.PLAST.NEGRO
OCT.4x1/2X3/4
REF A=0.22 REF B=0.34

**4.1/2"
x3/4"**

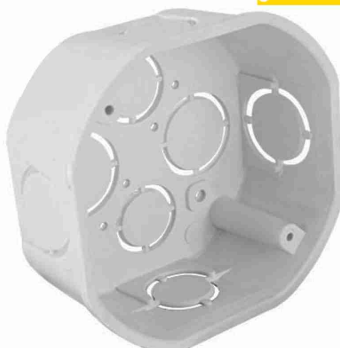

EMT-0785 REF C 0.73
PZA |CAJET.PLA BLAN.T/
PAV.ECON.4X1/2X3/4
REF A=0.46 REF B=0.69

4x4x1/2"



EMT-0790 REF C 1.41
PZA |CAJETIN PVC NEGRO.CUADRADO 4X4
X1/2
REF A=0.88 REF B=1.34

4x4x3/4"



EMT-0791 REF C 1.41
PZA |CAJETIN PVC NEGRO.CUADRADO 4X4 X3/4
REF A=0.88 REF B=1.34

**4X4
1/2X3/4**



EMT-0793 REF C 0.78
PZA |CAJET.PLA NEGR/PAVC CUA.4X4 1/2X3/4
REF A=0.49 REF B=0.74

**4X4
1/2X3/4**



EMT-0794 REF C 0.78
PZA |CAJET.PLA BL T/PAV ECO.4X4 1/2X3/4
REF A=0.49 REF B=0.74

10x10x7



EMT-0815 REF C 3.34
PZA |CAJA D/PASO PLASTICA 10 X 10 X 7 BL
REF A=2.09 REF B=3.18

15x15x10



EMT-0830 REF C 16.32
PZA |CAJA D/PASO PLASTICA 15 X 15 X 10 BL
REF A=10.19 REF B=15.5

**6x6cm
x6cm**



EMT-0857 REF C 12.07
PZA |CAJA DE PASO 6 X 6 X 6
REF A=7.53 REF B=11.46

**6x12cm
x6cm**

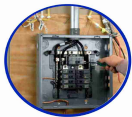

EMT-0863 REF C 24.21
PZA |CAJA DE PASO 6 X 12 X 6
REF A=15.11 REF B=23

**8x12cm
x4cm**

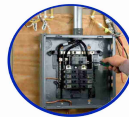

EMT-0880 REF C 24.7
PZA |CAJA DE PASO 8 X 12 X 4
REF A=15.42 REF B=23.47

**8x12cm
x6cm**



EMT-0883 REF C 26.73
PZA |CAJA DE PASO 8 X 12 X 6
REF A=16.68 REF B=25.39

**10x10cm
x4cm**



EMT-0915 REF C 24.7
PZA | CAJA DE PASO 10 X 10 X 4

REF A=15.42 REF B=23.47

**10x10cm
x6cm**



EMT-0917 REF C 26.73
PZA | CAJA DE PASO 10 X 10 X 6

REF A=16.68 REF B=25.39

**10x12cm
x6cm**



EMT-0921 REF C 29.77
PZA | CAJA DE PASO 10 X 12 X 6

REF A=18.58 REF B=28.28

**12x12cm
x4cm**



EMT-0931 REF C 30.26
PZA | CAJA DE PASO 12 X 12 X 4

REF A=18.89 REF B=28.75

**12x12cm
x6cm**



EMT-0934 REF C 35.3
PZA | CAJA DE PASO 12 X 12 X 6

REF A=22.04 REF B=33.54

**12x16cm
x6cm**

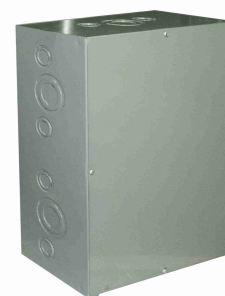

EMT-0939 REF C 42.88
PZA | CAJA DE PASO 12 X 16 X 6

REF A=26.77 REF B=40.74

**16x16cm
x6cm**



EMT-0947 REF C 53.48
PZA | CAJA DE PASO 16 X 16 X 6

REF A=33.38 REF B=50.81

**20x20cm
x6cm**



EMT-0951 REF C 78.18
PZA | CAJA DE PASO 20 X 20 X 6

REF A=48.8 REF B=74.28

**Q.C MINI
M L-3**



EMT-0985 REF C 12.29
PZA | CAJA PARA BREAKERS Q.C MINI M L-3

REF A=7.67 REF B=11.68



220V
50x40x20cm



EMT-1003 REF C 89.75
PZA |CAJA P/MEDI.ECON 2PT 220V
50X40X20

REF A=56.02 REF B=85.27

3/4"



EMT-2787 REF C 0.26
PZA |CONECTOR CONDUIT PVC 3/4

REF A=0.16 REF B=0.25

1/2"



EMT-2806 REF C 1.6
PZA |CONECTOR EMT 1.1/2"

REF A=1 REF B=1.52

2"



EMT-2808 REF C 1.99
PZA |CONECTOR EMT 2"

REF A=1.24 REF B=1.89

1/2"



EMT-2815 REF C 0.45
PZA |CONECTOR EMT ALUMINIO 1/2"

REF A=0.28 REF B=0.43

3/4"



EMT-2817 REF C 0.56
PZA |CONECTOR EMT ALUMINIO 3/4"

REF A=0.35 REF B=0.53

1"



EMT-2819 REF C 0.78
PZA |CONECTOR EMT ALUMINIO 1"

REF A=0.48 REF B=0.74

1.1/2"



EMT-2821 REF C 2.03
PZA |CONECTOR EMT ALUMINIO 1.1/2"

REF A=1.27 REF B=1.93

2"



EMT-2824 REF C 2.51
PZA |CONECTOR EMT ALUMINIO 2"

REF A=1.57 REF B=2.39



3"



EMT-2827 REF C 8.5
PZA | CONECTOR EMT ALUMINIO 3"

REF A=5.31 REF B=8.08



4"



EMT-2830 REF C 12.22
PZA | CONECTOR EMT ALUMINIO 4"

REF A=7.63 REF B=11.61



1/2"



EMT-3000 REF C 3.96
PZA | COPAS D/ENTRADA CABEZOTE 1/2"

REF A=2.47 REF B=3.76



3/4"



EMT-3050 REF C 3.96
PZA | COPAS D/ENTRADA CABEZOTE 3/4"

REF A=2.47 REF B=3.76



1"



EMT-3100 REF C 4.17
PZA | COPAS D/ENTRADA CABEZOTE 1"

REF A=2.6 REF B=3.96



1.1/2"



EMT-3150 REF C 5.98
PZA | COPAS D/ENTRADA CABEZOTE 1.1/2'

REF A=3.73 REF B=5.68



4"

EMT-3300 REF C 61.11
PZA | COPAS D/ENTRADA CABEZOTE 4"

REF A=38.15 REF B=58.06



1/2"



EMT-3600 REF C 1.91
PZA | CURVA P/ELECT.E.M.T 1/2"

REF A=1.19 REF B=1.81



3/4"



EMT-3602 REF C 3.25
PZA | CURVA P/ELECT.E.M.T 3/4"

REF A=2.03 REF B=3.09

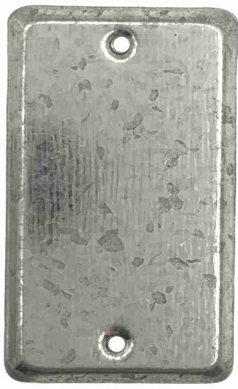

2x4

EMT-4900 REF C 0.99
PZA |TAPA CIEG.CAJETIN 2X4 METAL
RECTANG
REF A=0.62 REF B=0.94

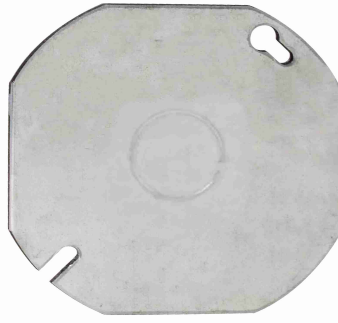

4"

EMT-4905 REF C 1.11
PZA |TAPA METAL CAJETIN 4"OCTOGON.C/
H
REF A=0.69 REF B=1.05



4"

EMT-4907 REF C 1.08
PZA |TAPA METAL CAJETIN 4"OCTOGON.S/H
REF A=0.68 REF B=1.03



4x4

EMT-4914 REF C 1.2
PZA |TAPA METAL CAJETIN 4X4"CUADR S/
H
REF A=0.75 REF B=1.14



4x4

EMT-4915 REF C 1.22
PZA |TAPA METAL CAJETIN 4X4"CUADR C/
H
REF A=0.76 REF B=1.16



5x5

EMT-4920 REF C 1.62
PZA |TAPA METAL CAJETIN 5X5 CUADR.C/H
REF A=1.01 REF B=1.54



5x5

EMT-4922 REF C 1.62
PZA |TAPA METAL CAJETIN 5X5 CUADR.S/H
REF A=1.01 REF B=1.54

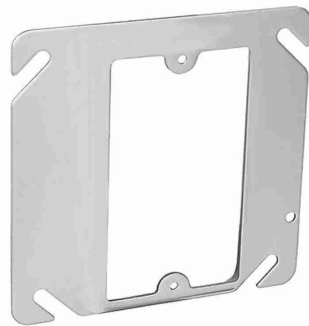

4x4 a 2x4

EMT-4930 REF C 1.39
PZA |MARCO REDUCTOR MET 4X4 A 2X4
LISO
REF A=0.87 REF B=1.32



**5X5 a 2X4
x 1/4**

EMT-4936 REF C 2.33
PZA |MARCO REDUCTOR MET.5X5 A 2X4 x
1/4
REF A=1.46 REF B=2.21

**2
CIRCUITOS**



EMT-4996 REF C 5.38
PZA | TABLE.RES.BIF.2CIR-C/T100A 110/220
REF A=3.36 REF B=5.11

**4
CIRCUITOS**



EMT-5003 REF C 9.79
PZA | TABLE.RES.BIF.4CIR-C/T100A 110/220
REF A=6.11 REF B=9.3

**6
CIRCUITOS**



EMT-5009 REF C 12.07
PZA | TABL.RESD.BIF.6CIR-C/T100A 110/220
REF A=7.53 REF B=11.46

**12
CIRCUITOS**



EMT-5380 REF C 364.21
PZA | TABLER R/I TRI 12CIR C/P
225ATP12FO
REF A=227.35 REF B=346.02

**24
CIRCUITOS**



EMT-5390 REF C 496.54
PZA | TABLER R/I TRI 24CIR C/P
225ATC24FO
REF A=309.95 REF B=471.74

**30
CIRCUITOS**



EMT-5395 REF C 547.54
PZA | TABLER R/I TRI 30CIR C/P
225ATP30FO
REF A=341.78 REF B=520.2

**42
CIRCUITOS**



EMT-5405 REF C 669.78
PZA | TABLER R/I TRI 42CIR C/P
225ATP42FO
REF A=418.09 REF B=636.33

**8 CIRCUITOS
CON PUERTA**



EMT-5425 REF C 44.73
PZA | TABLERO BIFAS.8C.C/PUERT.110/220
F
REF A=27.92 REF B=42.5

**12 CIRCUITOS
CON PUERTA**



EMT-5427 REF C 66.16
PZA | TABLERO BIFAS.12C.C/
PUERT.110/220F
REF A=41.3 REF B=62.86

30X20X15



EMT-5470 REF C 56.61
PZA | TABLER.P/CONTR.PUER/FUERA
40X20X15
REF A=35.34 REF B=53.79

30X30X15



EMT-5475 REF C 72.11
PZA | TABLERO P/CONTROL P/FUERA
30X30X15
REF A=45.01 REF B=68.51

40X30X15



EMT-5478 REF C 89.75
PZA | TABLER.P/CONTR.PUER/FUERA
40X30X15
REF A=56.02 REF B=85.27

**40x60cm
x20cm**



EMT-5486 REF C 175.73
PZA | TABL.P/CONTROL PUER/FUERA
40X60X20
REF A=109.69 REF B=166.95

**60x80cm
x25cm**



EMT-5494 REF C 333.81
PZA | TABLERO P/CONT.PUER/FUERA
60X80X25
REF A=208.37 REF B=317.14

**60x100cm
x30cm**



EMT-5497 REF C 427.28
PZA | TABLERO P/CONT.PUER/FUERA
60X100X30
REF A=266.72 REF B=405.94

**1/2"
x0.90mm**



EMT-6100 REF C 8.29
PZA | TUBO P/ELECT.E.M.T 1/2" X 0.90MM
REF A=5.17 REF B=7.88

**1"
x0.90mm**



EMT-6104 REF C 17.24
PZA | TUBO P/ELECT.E.M.T 1" X 0.90MM
REF A=10.76 REF B=16.38

**1.1/2"
x1.1mm**



EMT-6106 REF C 26.85
PZA | TUBO P/ELECT.E.M.T 1.1/2" X 1.1MM
REF A=16.76 REF B=25.51

2"
x1.1mm



EMT-6108 REF C 40.27
PZA | TUBO P/ELECT.E.M.T 2" X 1.1MM

REF A=25.14 REF B=38.26

3"
x1.4mm



EMT-6110 REF C 92.76
PZA | TUBO P/ELECT.E.M.T 3" X 1.4MM

REF A=57.9 REF B=88.13

4"
x1.4mm



EMT-6112 REF C 114.24
PZA | TUBO P/ELECT.E.M.T 4" X 1.4MM

REF A=71.31 REF B=108.53

3/8"x50M



TUBOflex

EMT-6177 REF C 25.4
RLL | TUBO CORRUG.PLAS.FLEX.NEGRO
3/8"50MT

REF A=15.86 REF B=24.13

1x25M



TUBOflex

EMT-6192 REF C 35.54
RLL | TUBO CORRUG.PLAS.FLEX.NEGRO
1"25MTS

REF A=22.18 REF B=33.76

1.1/2x25M



TUBOflex

EMT-6194 REF C 45.97
RLL | TUBO
CORRUG.PLAS.FLEX.NEGR.1.1/2"25M

REF A=28.69 REF B=43.67

2"x25M



TUBOflex

EMT-6196 REF C 59.96
RLL | TUBO CORRUG.PLAST.FLEX.NEGRO 2"
25MT

REF A=37.43 REF B=56.96

1"x25M



TUBOflex

EMT-6204 REF C 126.65
RLL | TUBO METAL FLEXIBLE E.M.T 1" 25M

REF A=79.06 REF B=120.32

1.1/2"x15M



TUBOflex

EMT-6206 REF C 143.39
RLL | TUBO METAL FLEXIBLE E.M.T 1.1/2"15M

REF A=89.51 REF B=136.23

2"x25M



EMT-6209 REF C 298.79
RLL | TUBO METAL FLEX.IMP E.M.T 2" 25MT

REF A=186.51 REF B=283.87

1X20



EXC-0300 REF C 8.14
PZA | BREAKER GENTE QP EMP.1X20
EXCELINE

REF A=5.08 REF B=7.73

1X30



EXC-0310 REF C 8.14
PZA | BREAKER GENTE QP EMP.1X30
EXCELINE

REF A=5.08 REF B=7.73

2X20



EXC-0318 REF C 17.98
PZA | BREAKER GENTE QP EMP.2X20
EXCELINE

REF A=11.23 REF B=17.08

2X30



EXC-0320 REF C 17.98
PZA | BREAKER GENTE QP EMP.2X30
EXCELINE

REF A=11.23 REF B=17.08

**14x51
20A**



EXC-2060 REF C 3.84
PZA | FUSIBLE CILINDRICO gG 14X51 20AMP

REF A=2.39 REF B=3.64

6 TOMAS



EXC-6100 REF C 14.64
PZA | REGLETA 6 TOMAS EXCELI
GMT-6-120S08

REF A=9.14 REF B=13.91

6 TOMAS



EXC-6105 REF C 16.73
PZA | REGLETA 6 TOMAS C/SUPRESOR PICO
EXC

REF A=10.44 REF B=15.89

120V



EXC-7500 REF C 15.11
PZA | PROTECT.NEVERA 120V C/TOM.GSM-
N120

REF A=9.43 REF B=14.35



120V

Excelsine

EXC-7510 REF C 33.69
PZA | PROTECT.NEVE.120V ULT/GEN.GSM-
NP120
REF A=21.03 REF B=32



120V

Excelsine

EXC-7516 REF C 20.45
PZA | PROTECT.LAVADORA Y LAV.DIGITAL
120V
REF A=12.77 REF B=19.43



**120V
18MBTU**

Excelsine

EXC-7520 REF C 32.71
PZA | PROTE.AIR/REF.120V 18MBTU.GSM-
RE120
REF A=20.42 REF B=31.07



**220V
48MBTU**

Excelsine

EXC-7523 REF C 32.71
PZA | PROTE.AIR/REF.220V 48MBTU.GSM-
RE220
REF A=20.42 REF B=31.07



**220V
18/48B**

Excelsine

EXC-7529 REF C 35.77
PZA | PROT.AIR.T/SPLI-CONSOLA.220V
18/48B
REF A=22.33 REF B=33.99



120V

Excelsine

EXC-7534 REF C 30.13
PZA | PRO.AIR/REF.BOR/BOR.ALT/
C.AJUS.120V
REF A=18.81 REF B=28.62



220V

Excelsine

EXC-7537 REF C 30.13
PZA | PRO.AIR/REF.BOR/BOR.ALT/
C.AJUS.220V
REF A=18.81 REF B=28.62



220V-3HP

Excelsine

EXC-7545 REF C 27.12
PZA | PRO.COMPRES.REF/AIR.B/B.220V3HP
30A
REF A=16.93 REF B=25.77



1.5HP 120V

Excelsine

EXC-7550 REF C 30.13
PZA | PROTECTOR MOTORES.1.5HP 120V
EXCEL
REF A=18.81 REF B=28.62

3HP 220V



Excelsine

EXC-7552 REF C 30.13
PZA |PROTECTOR MOTORES.MONOFAS.3HP
220V
REF A=18.81 REF B=28.62

3TOM-120V



Excelsine

EXC-7560 REF C 32.13
PZA |PRO.MULTIPR.ELECT.3TOM.120 GSM-
E120
REF A=20.06 REF B=30.53

120V



Excelsine

EXC-7563 REF C 20.45
PZA |PRO.MULTIP.ELECT.1TOM.120 GSM-
MP120
REF A=12.77 REF B=19.43

120V



Excelsine

EXC-7568 REF C 32.05
PZA |PROTEC.TV,LCD,LED,3T 120V GSM-
TV120
REF A=20 REF B=30.44

120V



Excelsine

EXC-7573 REF C 17.56
PZA |PROT.LAPTOPS/TABLETS/CELUL
GSM1P120
REF A=10.96 REF B=16.68

6 TOMAS



Excelsine

EXC-7600 REF C 83.61
PZA |PRO.EQUIP.ELECTR.C/PIC.FILT.L 6T1 20
REF A=52.19 REF B=79.43

110/220V



Excelsine

EXC-8100 REF C 52.01
PZA |RELOJ H.PROGRAMAB.DIG.B/B
110/220V
REF A=32.47 REF B=49.41

**20A
110-220V**



Excelsine

EXC-8102 REF C 52.01
PZA |REL.H.PROGRAM.ALTA CARGA 20A
110/220V
REF A=32.47 REF B=49.41

**TRIFASICO
220V**



Excelsine

EXC-8420 REF C 39.89
PZA |SUPERV.VOLT.CARGA M.TRIFASICO
220V
REF A=24.9 REF B=37.89

**TRIFÁSICO
208-220V**



Exceline

EXC-8423 REF C 39.89
PZA | SUPERV.VOLT.MOTOR-
BOM.TRIFA.208/220V
REF A=24.9 REF B=37.89

**TRIFÁSICO
220V**



Exceline

EXC-8430 REF C 116.95
PZA | SUPERV.VOLT.SIST.ELE.TRIF.PLUS 220V
REF A=73 REF B=111.11



Exceline

EXC-8595 REF C 36.65
PZA | TEMPORIZADOR MULTIRANGO EXC.
GTC-MR3
REF A=22.88 REF B=34.82



**10A
4 USB**



**Voltage
electronics part**

EXT-1092 REF C 16.11
PZA | EXTEN.MULT.2T.PICO 10A+4USB 2.1A
B01
REF A=10.05 REF B=15.3

**6 TOM-4 USB
2.4A-125V**



V-TEG

EXT-1095 REF C 28.36
PZA | REGL.ELECTR.6 TOM+4P USB 2.4A
125VTE
REF A=17.7 REF B=26.94

**3 TOMAS
2 USB**



V-TEG

EXT-1097 REF C 14.34
PZA | REGLETA-PROTECTOR 3TOM+2 USB
VTG/TRO
REF A=8.95 REF B=13.62

6 Tomas



**Voltage
electronics part**

EXT-1100 REF C 4.17
PZA | EXTENS.MULT.PLAS.6TOMA NEGRA
GT002B
REF A=2.61 REF B=3.97

3 TOMAS



DIESEL TOOLS

EXT-1101 REF C 2.27
PZA | EXTENSION.MULTIPLE.REGLETA
3TOMA DT
REF A=1.42 REF B=2.16

**10A
6TOMAS**



V-TEG

EXT-1102 REF C 3.91
PZA | EXTEN.MULTIPLE.6 TOMAS 10AMP DS
06G
REF A=2.44 REF B=3.71



**3M
6TOMAS**



EXT-1105 REF C 4.9
PZA | EXTENS.MULTIP.6 TOMA C/CAB 3MT
V882
REF A=3.06 REF B=4.65



**5M
6TOMAS**



EXT-1107 REF C 6.21
PZA | EXTENS.MULTIP.6 TOMA C/CAB 5MT
V883
REF A=3.87 REF B=5.9



8 TOMAS



EXT-1115 REF C 5.89
PZA | EXTENS.MULTIPLE.CUADRADA 8
TOMAS VTE
REF A=3.67 REF B=5.59



**2.7M
125V-9FT**



EXT-1180 REF C 1.63
PZA | EXT.SPT 2X18 C/3T NEGRA 2.7M 9FT
06
REF A=1.02 REF B=1.55



**3.65M
125V-12FT**



EXT-1183 REF C 1.79
PZA | EXT.SPT 2X18 C/3T NEG.3.65M 12FT
07
REF A=1.12 REF B=1.7



**4.57M
125V-15FT**



EXT-1186 REF C 1.95
PZA | EXT.SPT 2X18 C/3T NEG.4.57M 15FT
08
REF A=1.22 REF B=1.86



**6M
125V-20FT**



EXT-1188 REF C 2.46
PZA | EXT.SPT 2X18 C/3T NEG.6.00M 20FT
09
REF A=1.54 REF B=2.34



**7.62M
125V-25FT**



EXT-1190 REF C 2.78
PZA | EXT.SPT 2X18 C/3T NEG.7.62M 25FT
10
REF A=1.74 REF B=2.64



**1.80M
125V-6FT**



EXT-1200 REF C 1.47
PZA | EXT.SPT 2X18 C/3T.POL.1.80M 6FT 99
REF A=0.92 REF B=1.4



**2.70M
125V-9FT**

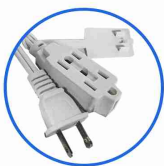

EXT-1205 REF C 1.63
PZA | EXT.SPT 2X18 C/3T.POL 2.70M 9FT
00
REF A=1.02 REF B=1.55



**6M
125V-20FT**

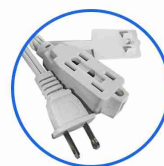

EXT-1220 REF C 2.46
PZA | EXT.SPT 2X18 C/3T POL.6.00M 20FT
03
REF A=1.54 REF B=2.34



**7.62M
125V-25FT**

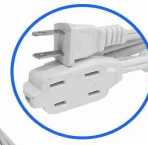

EXT-1221 REF C 2.78
PZA | EXT.SPT 2X18 C/3T POL.7.62M 25FT
04
REF A=1.74 REF B=2.64



**9.15M
125V-30FT**



EXT-1222 REF C 3.26
PZA | EXT.SPT 2X18 C/3T POL.9.15M 30FT
05
REF A=2.04 REF B=3.1



3T-2x18



EXT-1224 REF C 1.77
PZA | EXT.DOM.SPT 2x18 C/3T.POL1.8
6ftFM
REF A=1.1 REF B=1.68



**2x18-3T
2.7M**



EXT-1226 REF C 2.19
PZA | EXT.DOM.SPT 2x18C/3T.POL 2.7
9ftFM
REF A=1.37 REF B=2.08



**2x18-4.6
3 TOM-15FT**



EXT-1230 REF C 2.51
PZA | EXT.DOM.SPT 2x18C/3T.POL4.6
15ftFM
REF A=1.57 REF B=2.39



**2x18-3T
6M**



EXT-1232 REF C 3.48
PZA | EXT.DOM.SPT 2x18C/3T.6mt 18ft MXT
REF A=2.17 REF B=3.3



**1TOMA
7.62M**

EXT-1234 REF C 23.69
PZA | EXTENS.S/IND NARJ ST 1T 7.62Mt
REF A=14.79 REF B=22.51

**1 TOMA
15.24 M**



EXT-1236 REF C 35.35
PZA |EXTEN.S/IND NARJ ST 1T 15.24M 1022
REF A=22.06 REF B=33.58

**1 TOMA
30.48 M**



EXT-1237 REF C 67.3
PZA |EXTENS.S/IND NARJ ST 1T 30.48Mt
1224
REF A=42.01 REF B=63.94

**3 TOMA
7.62 M**



EXT-1240 REF C 20.37
PZA |EXT.NARANJA S/IND C/ST
3TOM.7.62FM
REF A=12.72 REF B=19.35

**3 TOMA
15.24 M**



EXT-1242 REF C 33.44
PZA |EXT.NARANJ.S/IND C/ST 3TOM
15.24FM
REF A=20.87 REF B=31.77

3x16-6M



EXT-1246 REF C 4.9
PZA |EXTENSION NARANJA ST 3X16
3T.6MT DT
REF A=3.06 REF B=4.65

3x16-4M



EXT-1247 REF C 3.64
PZA |EXTENSION NARANJA ST 3X16
3T.4MT DT
REF A=2.27 REF B=3.46

3x16-8M



EXT-1248 REF C 6.37
PZA |EXTENSION NARANJA ST 3X16
3T.8MT DT
REF A=3.97 REF B=6.05

3x16-10M



EXT-1249 REF C 7.54
PZA |EXTENSION NARANJA ST 3X16
3T.10MT D
REF A=4.71 REF B=7.17

3x16-15M



EXT-1250 REF C 8.41
PZA |EXTENSION NARANJA ST 3X16
3T.15MT D
REF A=5.25 REF B=7.99



**3x16cm
20M**



EXT-1251 REF C 11.24
PZA | EXTENSION NARANJA ST 3X16
3T.20MT D
REF A=7.01 REF B=10.68



3x14-4M

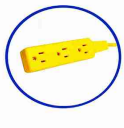

EXT-1266 REF C 4.74
PZA | EXTENS.AMARIL.ST 3X14 C/REGL.4
MT D
REF A=2.96 REF B=4.5



3x14-6M



EXT-1268 REF C 7.53
PZA | EXTENS.AMARIL.ST 3X14 C/REGL.6
MT D
REF A=4.7 REF B=7.16



3x14-8M

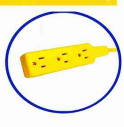

EXT-1270 REF C 7.17
PZA | EXTENS.AMARIL.ST 3X14 C/REGL.8
MT D
REF A=4.48 REF B=6.81



3x14-10M

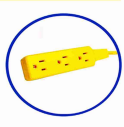

EXT-1272 REF C 10.38
PZA | EXTENS.AMARIL.ST 3X14 C/
REGL.10MT D
REF A=6.48 REF B=9.86



3x14-15M



EXT-1274 REF C 11.74
PZA | EXTENS.AMARIL.ST 3X14 C/
REGL.15MT D
REF A=7.33 REF B=11.16



4.5MT

EXT-1432 REF C 5.43
PZA | EXT:LAMP.AUX.MECAN P/MET
AMAR.4.5MT
REF A=3.39 REF B=5.16



15.24M



EXT-1435 REF C 11.83
PZA | EXTENS.LAMP.AUX.MECAN PANT/
MET15.24M
REF A=7.38 REF B=11.23



7.62 M



EXT-1437 REF C 5.97
PZA | EXT:LAMP.AUX.MECAN P/MET
AMAR.7.62M
REF A=3.72 REF B=5.67



23M



EXT-1439 REF C 14.79
PZA | EXTEN.LAMP.AUX.MECAN PANT/MET
23MT
REF A=9.24 REF B=14.06



30.48M



EXT-1441 REF C 17.95
PZA | EXTEN.LAMP.AUX.MEC. PANT/MET
30.48MT
REF A=11.21 REF B=17.06



3.65M

EXT-1560 REF C 1.41
PZA | EXTENSION TLF.DIG.PLANA P/CAJ
3.65M
REF A=0.88 REF B=1.34



**40u-21w
AHORRADOR**



ILU-1621 REF C 3.63
PZA | BOMB.AHORRAD.4U.T2 21W E-27
FMGOLD
REF A=2.26 REF B=3.45



**15w-110v
AHORRADOR**



ILU-1625 REF C 3.49
PZA | BOMB.AHORR.ESPIRAL MINI 15W
E-27FM
REF A=2.18 REF B=3.31



**20w-110v
AHORRADOR**



ILU-1627 REF C 3.58
PZA | BOMB.AHORR.ESPIRAL MINI 20W
E-27FM
REF A=2.23 REF B=3.4



**15w-MINI
AHORRADOR**



ILU-1635 REF C 3.53
PZA | BOMB.AHOR.ESP.MINI/MINI 15W
E-27FM
REF A=2.21 REF B=3.36



**15w-110v
AHORRADOR**



ILU-1640 REF C 3.39
PZA | BOMB.AHORR.ESPIRA.CORTO 15W
E-27FM
REF A=2.12 REF B=3.22



**20w-E27
AHORRADOR**



ILU-1642 REF C 3.77
PZA | BOMB.AHORR.ESPIRAL.20W E-27 FM
REF A=2.35 REF B=3.58

**T2-20w
AHORRADOR**



ILU-1643 REF C 4.4
PZA | BOMB.AHORR.ESP.T2 20W E-27
FMGOLD
REF A=2.75 REF B=4.18

**25w-E27
AHORRADOR**



ILU-1644 REF C 4.38
PZA | BOMB.AHORR.ESPIRAL.25W E-27 FM
REF A=2.73 REF B=4.16

**28W
AHORRADOR**



ILU-1646 REF C 4.38
PZA | BOMB.AHORR.ESPIRAL.28W E-27 FM
REF A=2.73 REF B=4.16

**105w-E27
AHORRADOR**



ILU-1651 REF C 9.42
PZA | BOMB.AHOR.IND.ESP.105WE-27 110V
FM
REF A=5.88 REF B=8.95

**105w-220V
E-27, AHORRADOR**



ILU-1652 REF C 9.42
PZA | BOMB.AHOR.IND.ESP.105WE-40 220V
FM
REF A=5.88 REF B=8.95

**105w-E40
AHORRADOR**



ILU-1760 REF C 10.24
PZA | BOMB.AHOR.IND.LOTU.105WE-40
220V FM
REF A=6.39 REF B=9.73

**125w-E40
AHORRADOR**



ILU-1762 REF C 10.24
PZA | BOMB.AHOR.IND.LOTU.125WE-40
220V FM
REF A=6.39 REF B=9.73

**65w-110v
E27**



ILU-1787 REF C 8.5
PZA | FTE/TWIST.JUMBO 65W 110 865 E-27
REF A=5.31 REF B=8.08

**2D-T5, 21W
AHORRADOR**



ILU-1885 REF C 2.24
PZA | FTE.AHOR./2D T-5 21W*CIRCU
LAM-1970
REF A=1.4 REF B=2.13

**2D-T5, 38W
AHORRADOR**



**CLASSIC
LUX**

ILU-1887 REF C 3.58
PZA | FTE.AHOR/2D T-5 38W*CIRCU
LAM-1975
REF A=2.23 REF B=3.4

**7W-A19
E27 110V**



ILU-2500 REF C 1.9
PZA | BOMBILLO LED 7W A-19 E-27 110V BJ
REF A=1.19 REF B=1.8

**9W-A19
E27 110V**



**TIMEX
LED LIGHTING FOR LIFE**

ILU-2510 REF C 1.61
PZA | BOMBILL LED 9W A-19 E-27 110V
TIMEX
REF A=1 REF B=1.53

9W



**Voltage
electronics part**

ILU-2570 REF C 5.54
PZA | BOMB.LED RECARGABL.9W A-19 E27
110V
REF A=3.46 REF B=5.26

**12W, A-19
RECARGABLE**

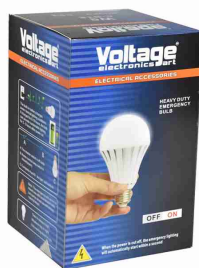

**Voltage
electronics part**

ILU-2572 REF C 6.93
PZA | BOMB.LED RECARGABL.12W A-19 E27
110
REF A=4.33 REF B=6.58

**9W-E27
110V**



**MAXI
LIGHT**

ILU-2590 REF C 1.23
PZA | BOMB.LED DOMO 9 W E-27 110VV
MAXI
REF A=0.77 REF B=1.17

**13W-E27
110v**



**MAXI
LIGHT**

ILU-2595 REF C 1.42
PZA | BOMB.LED DOMO 13W E-27 110VV
MAXI
REF A=0.89 REF B=1.35

**18w-E27
110v**



**MAXI
LIGHT**

ILU-2605 REF C 1.96
PZA | BOMB.LED DOMO 18W E-27 110VV
MAXI
REF A=1.22 REF B=1.86

**28w-E27
110v**



**MAXI
LIGHT**

ILU-2610 REF C 2.38
PZA | BOMB.LED DOMO 28W E-27 110V
MAXI
REF A=1.49 REF B=2.26



**38W-E27
110V**



ILU-2625 REF C 3.16
PZA | BOMB.LED DOMO 38W E-27 110V
MAXI
REF A=1.97 REF B=3

22W-T5



ILU-3000 REF C 1.3
PZA | TUBO FLUOR.CIRCULAR 22W T-5
HAPPYLI
REF A=0.81 REF B=1.24

22W



ILU-3010 REF C 2.1
PZA | TUBO FLUOR.CIRC.L/D 22W FM/XILCO
REF A=1.31 REF B=2

32W



ILU-3061 REF C 2.55
PZA | TUBO FLUOR.CIRC.L/D 32W FM POWER
REF A=1.59 REF B=2.43

6W- 120V



ILU-3076 REF C 1.2
PZA | TUBO FLUORES.LUZ NEGRA 6W 120V
IMP
REF A=0.75 REF B=1.14

**4w-T5
6500k**



ILU-3082 REF C 0.89
PZA | TUBO FLUORES.L/D T-5 4W 6500K
XILC
REF A=0.56 REF B=0.85

**6w-T5
6500k**



ILU-3084 REF C 1.01
PZA | TUBO FLUORES.L/D T-5 6W 6500K
XILC
REF A=0.63 REF B=0.96

**8w-T5
6500k**



ILU-3086 REF C 1.55
PZA | TUBO FLUORES.L/D T-5 8W 6500K
XILC
REF A=0.97 REF B=1.48

**10W-T8
130V**



ILU-3088 REF C 1.37
PZA | TUBO FLUO.L/D 10W T-8 130V FINO
PW
REF A=0.85 REF B=1.3

**15W-T8
130v**



ILU-3089 REF C 1.37
PZA | TUBO FLOUR L/D 15WT-8 130V FINO PW
REF A=0.85 REF B=1.3

**40W-T12
6500K**



ILU-3096 REF C 83.25
CJA | TUBO FLUOR.40W T-12 6500K CJ/25 PRL
REF A=51.96 REF B=79.09

**40W
RS-T12**



ILU-3097 REF C 4.87
PZA | TUBO FLUOR.40W RS T-12 DELTA LIGHT
REF A=3.04 REF B=4.63

**32W-T8
6500K**



ILU-3102 REF C 1.18
PZA | TUBO FLUOR.ELECT.T-8 32W 6500K FM
REF A=0.74 REF B=1.12

**300/118mm
130V**



ILU-3130 REF C 1.68
PZA | TUBO HALOGEN.300/118M-130V LARGO FM
REF A=1.63 REF B=1.77

**1500/118mm
110V**



ILU-3133 REF C 9.7
PAR | TUBO HALOG.1500/254M-110V L/FM PAR
REF A=6.06 REF B=9.22

**1500/254mm
220V**



ILU-3134 REF C 2.43
PZA | TUBO HALOGEN.1500/254M-220V LARG.F
REF A=1.51 REF B=2.3

**40W-110V
118mm**



ILU-3150 REF C 5.94
PZA | TUB LED 15W 118MM REEMPLAZO.HAL110V
REF A=3.71 REF B=5.65

**40W-220V
118mm**



ILU-3153 REF C 4.79
PZA | TUB.LED 15W 118MM REEMPLAZO HAL220V
REF A=2.99 REF B=4.55

300/118mm
110V

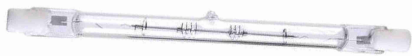

CLASSIC
LUX

ILU-3167

REF C 1.3

PZA | TUBO HALOGENO 300/118MM -110V
CLAS

REF A=0.81

REF B=1.23

500W-118M
220V



CLASSIC
LUX

ILU-3175

REF C 1.34

PZA | TUBO HALOGENO 500W/220V.118M
IMP

REF A=0.84

REF B=1.28

1500W-110V
254M



CLASSIC
LUX

ILU-3179

REF C 4.95

PZA | TUBO HALOGEN.1500W/110V 254M
IMP

REF A=3.09

REF B=4.7

1500W-220V
254M



CLASSIC
LUX

ILU-3183

REF C 2.45

PZA | TUBO HALOGEN.1500W/220V 254M
IMP

REF A=1.53

REF B=2.33

1000W-110V
254M



FM
FERMETAL

ILU-3191

REF C 1.18

PZA | TUBO HALOGENO 1000W/254M 110V
FM

REF A=0.74

REF B=1.12

160W-E27
120V



FM
FERMETAL

ILU-3195

REF C 4.76

PZA | BOMB.LUZ MIXT 160W.120V E-27FM/
PHO

REF A=2.97

REF B=4.52

160W-E27
220v

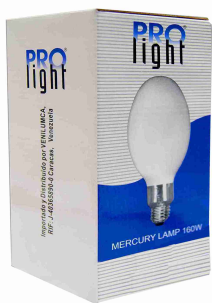

PRO
light

ILU-3202

REF C 3.63

PZA | BOMB.LUZ MIXTA 160W.220 E-27 FM/
PH

REF A=2.26

REF B=3.45

250W-E27
220V



FM
FERMETAL

ILU-3305

REF C 5.93

PZA | BOMBIL.LUZ MIX.250W.220 E-27 FM/
PH

REF A=3.7

REF B=5.64

500W-E40
220V



DB
DBLIGHT

ILU-3500

REF C 8.52

PZA | BOMB.LUZ MIXTA 500W.220V E-40 F/
SE

REF A=5.32

REF B=8.1

150w-E40



CLASSIC LUX

ILU-3545

REF C 15.31

PZA | BOMB.SODIO 150W E-40 TUB.4Y CLA OSR

REF A=9.56

REF B=14.54

250w-E40



FM FERMETAL CLASSIC LUX

ILU-3547

REF C 11.75

PZA | BOMB.SODIO 250W E-40 TUB.4Y CLA FM

REF A=7.34

REF B=11.16

250w-E40



CLASSIC LUX

ILU-3548

REF C 16.48

PZA | BOMB.SODIO 250W E-40 TUB.4Y CLA OSR

REF A=10.29

REF B=15.66

40W-R16 120V



ILU-3620

REF C 0.85

PZA | BOMB.S.BALUX R-16 40W.120V FROSTED

REF A=0.53

REF B=0.81

150-120W



XILCO

ILU-3700

REF C 13.73

PZA | BOMB.REFL.PAR38 150.120V PES/TRA O/F

REF A=8.57

REF B=13.04

100W 130HGL



FM FERMETAL

ILU-3704

REF C 13.73

PZA | BOMB.REFL.P/38 100W.130HGL-PES/AZU F

REF A=8.57

REF B=13.04

90W 120V



XILCO

ILU-3706

REF C 13.73

PZA | BOMB.REFL.PAR38 90W.120 PES/AZUL XIL

REF A=8.57

REF B=13.04

90W 120V



XILCO

ILU-3709

REF C 13.73

PZA | BOMB.REFL.PAR38 90W.120 PES/ROJO XIL

REF A=8.57

REF B=13.04

90W 120V



XILCO

ILU-3716

REF C 13.73

PZA | BOMB.REFL.PAR38 90W.120 PES/VERD XIL

REF A=8.57

REF B=13.04

**5W-E27
277V**

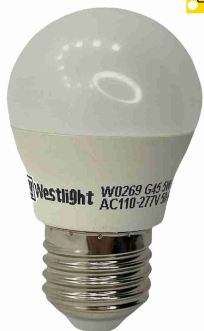

ILU-5067 REF C 3.06
PZA | BOM.MULT/U LED 5W E27
85-277V6500 W
REF A=1.91 REF B=2.91

**8W-A19
110V**



ILU-5900 REF C 5.11
PZA | BOMBIL.LED VINTAGE A19 8W 110
3000K
REF A=3.19 REF B=4.86

**40W
E27**

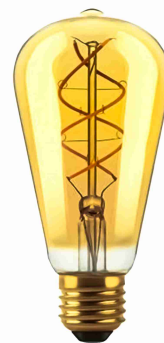

ILU-5905 REF C 7.14
PZA | BOMBILLO.VINTAGE SPIRAL 40W E27
CLAS
REF A=4.45 REF B=6.78

**40W
E27**



ILU-5907 REF C 7.14
PZA | BOMBILLO.VINTAGE SQUIREL 40W
E27 CL
REF A=4.45 REF B=6.78

**20/100W
E27**



ILU-6015 REF C 0.32
PZA | BOMB/DOMS.1000H E-27 20/100W
SUPER
REF A=0.2 REF B=0.31

**6W, E-12
3500K**



ILU-7435 REF C 2.17
PZA | BOMB.LED VELA 6W E-12 85-265
3500K
REF A=1.35 REF B=2.06

**6W, E-12
6500K**



ILU-7437 REF C 2.17
PZA | BOMB.LED VELA 6W E-12 85-265
6500K
REF A=1.35 REF B=2.06

**40W-E14
120V**



ILU-7490 REF C 0.64
PZA | BOMBILLO VELA 40W E-14 120V CLA
IMP
REF A=0.4 REF B=0.6

**40W-E12
120V**



ILU-7525 REF C 2.24
PZA | BOMBILLO VELA 40W E-14 120V
CL.WEST
REF A=1.4 REF B=2.13

**60W-E14
120V**



ILU-7552

REF C 0.66

PZA | BOMBILLO VELA 60W E-14 120V CLA FM

REF A=0.41

REF B=0.63

**5W-E14
110V**



ILU-7556

REF C 2.31

PZA | BOM.VELA LED VINTAG 5W E14 110 3000

REF A=1.44

REF B=2.19

**2W-E14
265V**

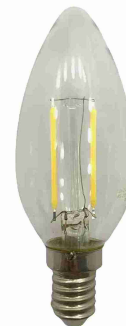

ILU-7557

REF C 1.41

PZA | BOMB.VELA LED 2W E-14 85-265V 2700K

REF A=0.88

REF B=1.34

**6W-E14
85-277V**



ILU-7558

REF C 2.35

PZA | BOMB.VELA LED 6W E14 85-277V6500K W

REF A=1.47

REF B=2.24

**2W-E27
85-265V**



ILU-7562

REF C 2.75

PZA | BOMB.VELA LED 2W E-27 85-265V 2700K

REF A=1.72

REF B=2.61

**2W-E27
85-265V**



ILU-7563

REF C 2.75

PZA | BOMB.VELA LED 2W E-27 85-265V 6500K

REF A=1.72

REF B=2.61

**5W-E27
110V**



ILU-7564

REF C 3.39

PZA | BOM.VELA LED VINTAG 5W E27 110 3000

REF A=2.12

REF B=3.22

**15W-E14
AHORRADOR**



ILU-7565

REF C 7.42

PZA | BOMBILLO VELA AHORRADO.E-14 15W FM

REF A=4.63

REF B=7.05

**40W-E27
120V**



ILU-7592

REF C 0.64

PZA | BOMBILLO VELA 40W E-27 120 CLA FM

REF A=0.4

REF B=0.6

**6W, E-12
120 V**



**CLASSIC
LUX**

ILU-7705 REF C 0.54
PZA | BOMBILLO AJI TRASP.6W 120V E-12
REF A=0.34 REF B=0.51

**5W-E12
120V**



**CLASSIC
LUX**

ILU-7710 REF C 0.64
PZA | BOMBILLO AJI D.COLORE.5W 120V
E-12
REF A=0.4 REF B=0.6

**2.5W-G4
110V-3K**



ILU-7865 REF C 4.24
PZA | BOMBIL.LED.BIPIN 110V G4 2.5W
3000K
REF A=2.65 REF B=4.03

**50W-GY6
120V**



**FM
FERMETAL**

ILU-7880 REF C 5.04
PZA | BOMB.HALOG.BIPIN 120V GY6.35
50WFM
REF A=3.15 REF B=4.79

**2.5W-G9
110V-3K**



**FM
FERMETAL**

ILU-7890 REF C 4.24
PZA | BOMBIL.LED.BIPIN 110V G9 2.5W
3000K
REF A=2.65 REF B=4.03

**20W
MR11-12V**



ILU-8109 REF C 1.39
PZA | DICROIC BIP 12V 20W C/PANT MR-11
FM
REF A=0.87 REF B=1.32

**50W
11V-MR16**



**CLASSIC
LUX**

ILU-8125 REF C 1.44
PZA | DICROICO BIP 12V 50W S/PANT MR-16
REF A=0.9 REF B=1.36

**50W
MR11-110V**



**FM
FERMETAL**

ILU-8137 REF C 1.44
PZA | DICROI BIP 50W S/PANT MR-11 110V
FM
REF A=0.9 REF B=1.36

**50W
130V**



**CLASSIC
LUX**

ILU-8142 REF C 1.65
PZA | DICROICO BIP.50W 130 JCDR S/PANT
REF A=1.03 REF B=1.57

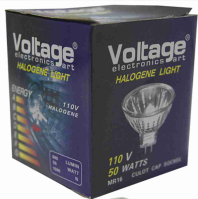

50W-110V



Voltage
electronics part

ILU-8150 REF C 1.72
PZA | DICRO.BIP.50W1 10 JCDR C/PANT SH/
FM
REF A=1.07 REF B=1.63

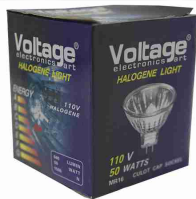

**50W
130V**



Voltage
electronics part

ILU-8152 REF C 0.64
PZA | DICROICO BIP.50W 130 JCDR C/PANT
LU
REF A=0.4 REF B=0.61

**3W-MR16
110V**



**CLASSIC
LUX**

ILU-8154 REF C 2.05
PZA | BOMB.DICROIC LED MR-16 3W 110
6500K
REF A=1.28 REF B=1.95

**5W-MR16
110V-3K**



V-TEG

ILU-8155 REF C 2.6
PZA | BOMB.DICROIC LED MR-16 5W 110
6000K
REF A=1.63 REF B=2.47

**7W-MR16
85-265V**



**ecco
green**
Lighting

ILU-8156 REF C 2.3
PZA | BOMB.DICRO.LED MR-16 7W
85-265V6500
REF A=1.43 REF B=2.18

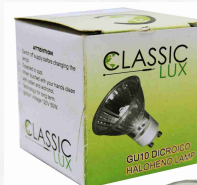

**50W-GU10
120V**



**CLASSIC
LUX**

ILU-8157 REF C 1.51
PZA | BOMB DIC.SEG.GU10 S/PANT 50W130
FM
REF A=0.94 REF B=1.43

**7W-GU10
85-265V**



**ecco
green**
Lighting

ILU-8159 REF C 1.92
PZA | BOMB.DICRO.LED GU10 7W 85-265V
6500
REF A=1.2 REF B=1.82

**5W GU10
110**



**CLASSIC
LUX**

ILU-8160 REF C 1.73
PZA | BOM DICR.LED.5W GU10 C/PAN 110
6500
REF A=1.08 REF B=1.64

**7W-GU10
110V-3000K**



**ecco
green**
Lighting

ILU-8161 REF C 2.98
PZA | BOMB.DICROICO LED GU10 7W 110
3000K
REF A=1.86 REF B=2.83

**7W-110V
6K-GU10**



ILU-8162 REF C 2.98
PZA | BOMB.DICROICO LED GU10 7W 110
6000K
REF A=1.86 REF B=2.83

**7.5W
18LED-110V**



ILU-8163 REF C 2.98
PZA | BOM DICR.18 LED.JDR 7.5W C/T110V
FM
REF A=1.86 REF B=2.83

**16LED-E27
110V**



ILU-8164 REF C 2.47
PZA | BOM DICR.16 LED.JDR E-27 3X1W/
T110V
REF A=1.54 REF B=2.35

**50W
15LED-110V**



ILU-8165 REF C 2.18
PZA | BOM DICR.15 LED.JCRD 50W C/T110V
FM
REF A=1.36 REF B=2.07

**15LED-50W
110V-MR11**



ILU-8170 REF C 2.18
PZA | BOM DICR.15 LED.MR11 50W C/
T110V FM
REF A=1.36 REF B=2.07

**11W-110V
AHORRADOR**



ILU-8200 REF C 1.39
PZA | DICROICO AHORRD.ESPIRAL.11W 110V
REF A=0.87 REF B=1.32

**11W
AHORRADOR**



ILU-8210 REF C 4.29
KIT | DICROI.**KIT**BOMB/BALAST
AHOR.11W
REF A=2.68 REF B=4.07

22W



LAM-0950 REF C 4.27
PZA | LAMP.ELEC PLAFO.22W C/T RED.BLA
FM
REF A=2.67 REF B=4.06

2W



LAM-0955 REF C 3.62
PZA | LAMP.ELEC PLAFON.2W C/T
CUAD.BLA F
REF A=2.26 REF B=3.44

22W



LAM-0960 REF C 3.68
PZA | LAMP.ELEC PLAF.22W C/T RED.2COLR F
REF A=2.3 REF B=3.5

22W



LAM-0965 REF C 5.25
PZA | LAMP.ELEC PLAF.22WC/T CUAD.2COLR F
REF A=3.28 REF B=4.99

22W-T5



LAM-1000 REF C 6.62
PZA | LAMP.CIRC.22W T-5 COMPL.C/TUBO KIT
REF A=4.13 REF B=6.29

22W



LAM-1008 REF C 6.21
PZA | LAM.CIRC.ELECT.MET.22W C/CRO.C/TUB
REF A=3.87 REF B=5.9

22W



LAM-1009 REF C 6.92
PZA | LAM.CIRC.ELECT.PVC.22W C/CRO.C/TUB
REF A=4.32 REF B=6.58

32W



LAM-1017 REF C 2.4
PZA | LAMP.CIRC.ELECTRONI.32W C/CROS S/TB
REF A=1.5 REF B=2.28

PVC 32W



LAM-1018 REF C 2.86
PZA | LAM.CIRC.ELECT.PVC.32W C/CRO.C/TUB
REF A=1.79 REF B=2.72

1x15



LAM-1180 REF C 1.6
PZA | LAMPARA COMER.ELECTRONIC.1X15 S/TB
REF A=1 REF B=1.52

1x20



LAM-1210 REF C 2.44
PZA | LAMPARA COMER.ELECTRONIC.1X20 S/TB
REF A=1.52 REF B=2.32



1x20



LAM-1212 REF C 2.86
PZA | LAMPAR COMER.ELECT.CROMA.1X20 S/TB

REF A=1.79 REF B=2.72



1x40



LAM-1360 REF C 4.78
PZA | LAMPARA COMER.ELECTRONI.1X40 S/TB

REF A=2.98 REF B=4.54



1x40



LAM-1363 REF C 5.43
PZA | LAMPAR COMER.ELECT.CROMA.1X40 S/TB

REF A=3.39 REF B=5.16



1x40



LAM-1365 REF C 3.33
PZA | LAMPAR INDUS.ELECT.BLAN.1X40 S/TB

REF A=2.08 REF B=3.16



1x40



LAM-1367 REF C 4.54
PZA | LAMPAR INDUS.ELEC.CROMAD 1X40 S/TB

REF A=2.84 REF B=4.31



2x40



LAM-1410 REF C 5.72
PZA | LAMPARA COMER.ELECTRONI.2X40 S/TB

REF A=3.57 REF B=5.43



2x40

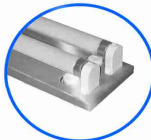

LAM-1411 REF C 4.73
PZA | LAMPAR COMER.ELECT.CROMA 2X40 S/TB

REF A=2.95 REF B=4.49



2x40



LAM-1420 REF C 6.58
PZA | LAMPAR INDUS.ELECTRONIC.2X40 S/TB

REF A=4.11 REF B=6.25



2x40



LAM-1421 REF C 6.04
PZA | LAMPAR INDUS.ELECT.CROMA.2X40 S/TB

REF A=3.77 REF B=5.74

3X17W



LAM-1440 REF C 24.46
PZA | LAMP. ESPECULAR EMP 3X17W ECON S/
TUB
REF A=15.27 REF B=23.24

3x32W



LAM-1444 REF C 63.26
PZA | LAMP. ESPECULA. EMP 3X32W ECON. C/
TUB
REF A=39.49 REF B=60.1

3x32W



LAM-1445 REF C 19.43
PZA | LAMP. ESPECULA. EMP 3X32W ECON. S/
TUB
REF A=12.13 REF B=18.46

**17W-T5
6500K**

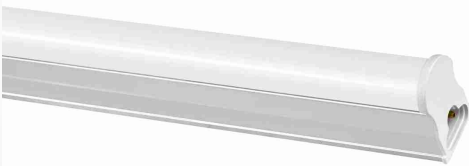

LAM-1465 REF C 8.55
PZA | LAMP. ELECTR. S/TUBO T-5 17W 6500K
61CM
REF A=5.34 REF B=8.12

**21W-T5
99cm**



LAM-1466 REF C 8.9
PZA | LAMP. ELEC. C/TUB+TAP+INT T-5 21W
99CM
REF A=5.56 REF B=8.46

**28W-T5
117cm**



LAM-1468 REF C 8.9
PZA | LAMP. ELECT. C/TUB T-5 28W 865
117CM
REF A=5.56 REF B=8.46

**32W-T5
122cm**



LAM-1469 REF C 8.67
PZA | LAMP. ELEC. S/TUBO T-5 32W 6500K
122CM
REF A=5.41 REF B=8.23

1x40



LAM-1472 REF C 9.76
PZA | LAMP. ELECT REFLECT. C/REJI/COMP
1X40
REF A=6.09 REF B=9.27

2x40

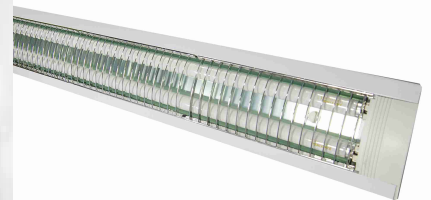

LAM-1476 REF C 14.1
PZA | LAMP. ELECT REFLEC. C/REJI/COMP
2X40
REF A=8.8 REF B=13.39

1x20



LAM-1480 REF C 4.41
PZA | LAMP.ELEC REFLE.C/PANT.X-PLAN
1X20

REF A=2.75 REF B=4.19

1x40



LAM-1481 REF C 4.91
PZA | LAMP.ELEC REFLE.C/PANT.X-PLAN
1X40

REF A=3.07 REF B=4.67

2X40



LAM-1484 REF C 14.1
PZA | LAMP.ELEC REFLE.C/PANT.X-PLAN
2X40

REF A=8.8 REF B=13.39

**3 NIVELES
20 LEDs**

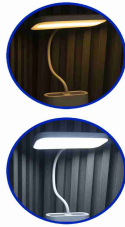

LAM-1567 REF C 7.41
PZA | LAMP.LED RECARGAB.USB 3NIV.20LED
21

REF A=4.63 REF B=7.04



LAM-1570 REF C 4.57
PZA | LAMP.LED USB CON CONTROL VOZ
360°NV

REF A=2.86 REF B=4.35

**2w
12 LEDs**

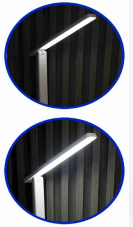

LAM-1572 REF C 5.67
PZA | LAMP.12LED RECARGABLE
PLEGABLE.2W 16

REF A=3.54 REF B=5.39

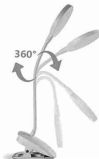

LAM-1574 REF C 6.8
PZA | LAMP.MES.12LED TACT.USB 3NIV
CLIP18

REF A=4.24 REF B=6.46



**110-220v
24 LEDs**



LAM-1576 REF C 7.41
PZA | LAMP.LED RECAR.AJUS.US.110/220
24L-19

REF A=4.63 REF B=7.04



LAM-1578 REF C 6.63
PZA | LAMP.MES.20LED TAC.RECAR.USB
3NIV20

REF A=4.14 REF B=6.3



LAM-1595 REF C 13.38
 PZA | LAMPARA LED EMERGENCIA TRABAJO
 VTEG
 REF A=8.35 REF B=12.71



LAM-1700 REF C 22.74
 PZA | LAMPARA EMERGENC.LED 2W
 100MIN.VT01
 REF A=14.2 REF B=21.6



LAM-1702 REF C 24.61
 PZA | LAMPARA EMERGENC.LED 8W 100MIN
 V200
 REF A=15.36 REF B=23.38



LAM-1705 REF C 25.82
 PZA | LAMP.EMERGENC.LED 5W
 100-240V+-3HVT
 REF A=16.12 REF B=24.53



LAM-1707 REF C 35.8
 PZA | LAMPARA EMERGENCIA LED 2 FOCOS
 REF A=22.34 REF B=34.01



LAM-1714 REF C 13.75
 PZA | LAMPARA EMERGEN.RECARGAB.60LED
 VT95
 REF A=8.58 REF B=13.06



LAM-1721 REF C 12.23
 PZA | LAMPARA P/EMB.C/VID 1BO BLA 6.5"
 REF A=7.63 REF B=11.62



LAM-1728 REF C 7.17
 PZA | LAMP.EMB.8"BL C/VID.2BO/AH.E-27S/B
 REF A=4.48 REF B=6.81



LAM-1729 REF C 11.61
 PZA | LAMP.EMB.8"NIQ C/VI.2BO/AH.E-27S/B
 REF A=7.25 REF B=11.03

6" E27



LAM-1735 REF C 12.67
PZA | LAMP.EMB.6"BL C/REJ.2BO/AH.E-27S/B

REF A=7.91 REF B=12.03

8" E-27



LAM-1737 REF C 15.98
PZA | LAMP.EMB.8"BL C/REJ.2BO/AHO.E27S/B

REF A=9.98 REF B=15.18

3" E27



LAM-1745 REF C 0.65
PZA | LAMP.SPOT EMB.3"B/INOX E-27P/BOM.A

REF A=0.41 REF B=0.62

3" E27



LAM-1747 REF C 0.65
PZA | LAMP.SPOT EMB.3"B/BLA E-27P/BOM.AH

REF A=0.41 REF B=0.62

4" E27



LAM-1748 REF C 1.11
PZA | LAMP.SPOT EMB.4"B/INOX E-27 P/BOMA

REF A=0.7 REF B=1.06

4" E27



LAM-1749 REF C 5.27
PZA | LAMP.SPOT EMB.4"B/BLA E-27C/T-VIDR

REF A=3.29 REF B=5

4" E27



LAM-1750 REF C 1.11
PZA | LAMP.SPOT EMB.4"B/BLA E27 P/BOM.AH

REF A=0.7 REF B=1.06

5" E27



LAM-1752 REF C 1.31
PZA | LAMP.SPOT EMB.5"B/BLA E27 P/BOM.AH

REF A=0.82 REF B=1.24

6" E27



LAM-1753 REF C 1.54
PZA | LAMP.SPOT EMB.6"B/BLA E-27P/BOM.AH

REF A=0.96 REF B=1.46

**5"
E27**



**CLASSIC
LUX**

LAM-1754 REF C 1.31
PZA | LAMP.SPOT EMB.5"B/INOX E-27P/
BOM.A
REF A=0.82 REF B=1.24

**8"-E27
100W**



**FM
FERMETAL**

LAM-1762 REF C 10.36
PZA | PLAFON VIDR/PVC RED.8"E-27 100W
FM
REF A=6.47 REF B=9.84

**8"
E27**



**FM
FERMETAL**

LAM-1764 REF C 6.11
PZA | PLAFON DE VIDRIO CRISTAL 8" E-27
REF A=3.82 REF B=5.81



LAM-1770 REF C 3.06
PZA | PLAFON DE VIDRIO:TAPA SOLA S/
SOCAT
REF A=1.91 REF B=2.9

150W



V-TEG

LAM-1840 REF C 94.65
PZA | LUMIN.LED C/FOTOC.100-265 150W
6400K
REF A=59.08 REF B=89.93

**45W
E27**



SPLENDOR
Iluminando tu vida

LAM-1854 REF C 33.97
PZA | LUMIN.T/ALUM.PUBL.C/BRA 45WE27
S/B
REF A=21.2 REF B=32.27



V-TEG

LAM-1860 REF C 104.45
PZA | LUMIN.LED C/FOTOC.100-265 200W
6400K
REF A=65.2 REF B=99.23

400W



**FM
FERMETAL**

LAM-1875 REF C 60.56
PZA | LUMINAR.METALHA.C/EQIP/
BOM.400W FM
REF A=37.8 REF B=57.53

**9W
CÁLIDA**



**Voltage
electronics Part**

LAM-1919 REF C 3.16
PZA | LAMPAR.LED RED.EMP.9W 85-265V
3500
REF A=1.97 REF B=3





**12W
CÁLIDA**



**Voltage
electronics part**

LAM-1921 REF C 3.53
PZA | LAMPAR.LED RED.EMP.12W 85-265V
3500
REF A=2.2 REF B=3.36



**18W
CÁLIDA**



**Voltage
electronics part**

LAM-1922 REF C 4.49
PZA | LAMPAR.LED RED.EMP.18W 85-265V
3500
REF A=2.81 REF B=4.27



**24W
CÁLIDA**



**Voltage
electronics part**

LAM-1923 REF C 7.17
PZA | LAMPAR.LED RED.EMP.24W 85-265V
3500
REF A=4.48 REF B=6.81

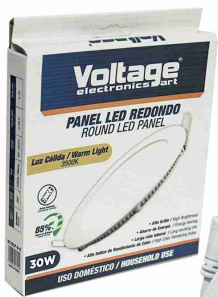

**30W
CÁLIDA**



**Voltage
electronics part**

LAM-1924 REF C 9.47
PZA | LAMPAR.LED RED.EMP.30W 85-265V
3500
REF A=5.91 REF B=9



**9W
CÁLIDA**



**Voltage
electronics part**

LAM-1926 REF C 3.53
PZA | LAMPAR.LED CUAD.EMP.9W 85-265V
3500
REF A=2.2 REF B=3.36

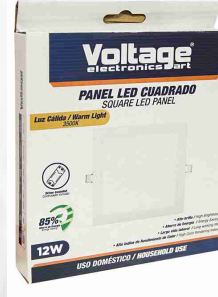

**12W
CÁLIDA**



**Voltage
electronics part**

LAM-1928 REF C 3.85
PZA | LAMPAR.LED CUAD.EMP.12W 85-265V
3500
REF A=2.4 REF B=3.66

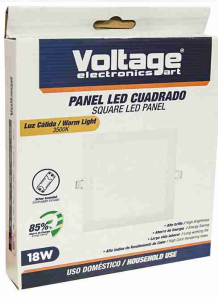

**18W
CÁLIDA**



**Voltage
electronics part**

LAM-1930 REF C 4.98
PZA | LAMPAR.LED CUAD.EMP.18W 85-265V
3500
REF A=3.11 REF B=4.73



**24W
CÁLIDA**



**Voltage
electronics part**

LAM-1932 REF C 8
PZA | LAMPAR.LED CUAD.EMP.24W 85-265V
3500
REF A=4.99 REF B=7.6

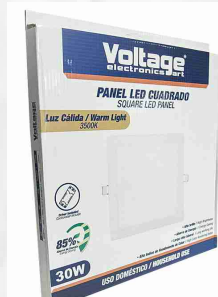

**30W
CÁLIDA**



**Voltage
electronics part**

LAM-1934 REF C 10.43
PZA | LAMPAR.LED CUAD.EMP.30W 85-265V
3500
REF A=6.51 REF B=9.91

**60w
E27**



LAM-1940 REF C 11.91
PZA | LAMP.APLIQUE CAROLINA E-27 60W
BLA
REF A=7.43 REF B=11.31

**60w
E27**



LAM-1942 REF C 11.91
PZA | LAMP.APLIQUE CAROLINA E-27 60W
NEG
REF A=7.43 REF B=11.31

**21w
T5**



LAM-1970 REF C 6.26
PZA | LAMP.PLAF.ELEC./DIF*T/DOB T-5
21W
REF A=3.91 REF B=5.95

**38w
T5**



LAM-1975 REF C 5.11
PZA | LAMPA.REDO.ELEC.BLAN-DOB T-5 38W
REF A=3.19 REF B=4.86

T-5 38W



LAM-2017 REF C 3.65
PZA | LAMPA.REDO.ELC.GRIS*BLA-DOB T-5
38W
REF A=2.28 REF B=3.47

**38w
T5**

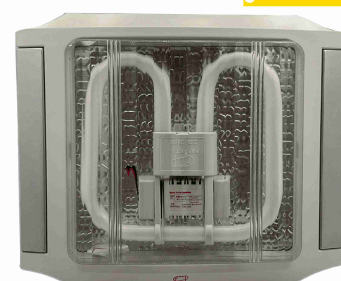

LAM-2019 REF C 2.75
PZA | LAMPA.CUAD.ELC.GRIS*BLA-DOB T-5
38W
REF A=1.72 REF B=2.61

**9x2"
E27**



LAM-2447 REF C 13.88
PZA | LAMP.SUPERF.RED.9"2xE27 C/V SAT
102
REF A=8.66 REF B=13.18

**30w
T5**



LAM-2464 REF C 12.13
PZA | LAMPARA CAMPANA LED E-27 PLATA
30W
REF A=7.57 REF B=11.52

**50w
T5**



LAM-2468 REF C 23.07
PZA | LAMPARA CAMPANA LED E-27 PLATA
50W
REF A=14.4 REF B=21.92

**65W
12"**



**CLASSIC
LUX**

LAM-2495 REF C 15.12
PZA | LAMP. EXTE. C/FOTOC.+BOM AHO 65W
12"
REF A=14.45 REF B=15.94

18W



**Voltage
electronics Part**

LAM-2625 REF C 5.38
PZA | LAMP. LED RED. SUP. 18W 85-265 6500
C/B
REF A=3.36 REF B=5.11

**3W
6500k**



V-TEG

LAM-2700 REF C 2.58
PZA | LAMPAR. LED RED. EMP. 3W 85-265
6500VT
REF A=1.61 REF B=2.45



**3W
3000k**



V-TEG

LAM-2701 REF C 2.14
PZA | LAMPAR. LED RED. EMP. 3W 85-265
3000VT
REF A=1.34 REF B=2.04



**6W
6500k**



V-TEG

LAM-2702 REF C 3.17
PZA | LAMPAR. LED RED. EMP. 6W 85-265
6500VT
REF A=1.98 REF B=3.01



**6W
3000k**



V-TEG

LAM-2703 REF C 2.73
PZA | LAMPAR. LED RED. EMP. 6W 85-265
3000VT
REF A=1.7 REF B=2.59



**9W
6500k**



V-TEG

LAM-2704 REF C 3.43
PZA | LAMPAR. LED RED. EMP. 9W 85-265
6500V
REF A=2.14 REF B=3.26

**15W-6.5"
6500k**



LAM-2706 REF C 3.29
PZA | LAMPAR. LED RED. EMP. 15W 6.5" 6500 C
REF A=2.05 REF B=3.13



12W



**Voltage
electronics Part**

LAM-2720 REF C 3.91
PZA | LAMPAR. LED RED. EMP. 12W 85-265
6500V
REF A=2.44 REF B=3.71



LAM-2728 REF C 8.04
 PZA | LAMP. LED RED. EMP. 24W 85-265
 6500V
 REF A=5.02 REF B=7.63



LAM-2735 REF C 3.88
 PZA | LAMP. LED 4" RED. EMP. 3/3W 65K AZUL/
 BL
 REF A=2.42 REF B=3.69



LAM-2737 REF C 8.5
 PZA | LAMP. LED 6" RED. EMP. 3/6W 65K AZUL/
 BL
 REF A=5.3 REF B=8.07



LAM-2740 REF C 3.16
 PZA | LAM. PANE. LED 3W CUAD. EMP. 85-265
 6500
 REF A=1.97 REF B=3



LAM-2741 REF C 3.16
 PZA | LAM. PANE. LED 3W CUAD. EMP. 85-265
 3000
 REF A=1.97 REF B=3



LAM-2742 REF C 3.93
 PZA | LAM. PAN. LED 6W CUAD. EMP. 85-265
 6500V
 REF A=2.45 REF B=3.74



LAM-2743 REF C 3.61
 PZA | LAM. PAN. LED 6W CUAD. EMP. 85-265
 3000V
 REF A=2.25 REF B=3.43



LAM-2744 REF C 3.93
 PZA | LAM. PAN. LED 9W CUAD. EMP. 85-265
 6500K
 REF A=2.45 REF B=3.74



LAM-2746 REF C 4.57
 PZA | LAM. PANEL LED 12W
 CUAD. EMP. 7" 6500K
 REF A=2.86 REF B=4.35



**18W
6500k**



LAM-2748 REF C 6.29
PZA | LAM.PAN.LED 18W CUAD.EMP.85-265
6500
REF A=3.92 REF B=5.97



**24W
6500k**



LAM-2751 REF C 9.44
PZA | LAM.PAN.LED 24W CUAD.EMP.85-265
6500
REF A=5.9 REF B=8.97

**24W
30x60**



LAM-2900 REF C 32.87
PZA | LAMPARA PANEL LED 24W 30X60
CLASS
REF A=20.52 REF B=31.23

**36W
60x60**



LAM-2905 REF C 38.7
PZA | LAMPARA PANEL LED 36W 60X60
CLASS
REF A=24.16 REF B=36.77

60W



LAM-3100 REF C 7.68
PZA | LAMP.VAPOL.MORR.PEQ PLA.BL 60W
C/R
REF A=4.79 REF B=7.29

60W



LAM-3107 REF C 7.68
PZA | LAMP.VAPOL.MORRO.PLA.BLA 60W S/
REJ
REF A=4.79 REF B=7.29

60W



LAM-3110 REF C 7.68
PZA | LAMP.VAPOL.MORRO.PLA.NEG 60W S/
REJ
REF A=4.79 REF B=7.29

60W



LAM-3117 REF C 10.08
PZA | LAMP.VAPOL.MORR.GRD PLA.NEG 60W
C/R
REF A=6.29 REF B=9.58

60W



LAM-3125 REF C 10.08
PZA | LAMP.VAPOL.REDON.PLA.BLA 60W C/
REJ
REF A=6.29 REF B=9.58

60w



CLASSIC LUX

LAM-3127 REF C 10.08

PZA | LAMP.VAPOL.REDON.PLA.NEG 60W C/REJ

REF A=6.29 REF B=9.58

100w



CLASSIC LUX

LAM-3132 REF C 10.08

PZA | LAMP.VAPOL.REDON.PLA.BLA 100W C/REJ

REF A=6.29 REF B=9.58

100w



CLASSIC LUX

LAM-3134 REF C 9.51

PZA | LAMP.VAPOL.REDON.PLA.NEG 100W C/REJ

REF A=5.94 REF B=9.04

60w



CLASSIC LUX

LAM-3170 REF C 11.77

PZA | LAMP.VAP.EMPOT.CAMINER.NEG 60W C/R

REF A=7.34 REF B=11.18

60w



CLASSIC LUX

LAM-3172 REF C 11.77

PZA | LAMP.VAP.EMPO.CAMINERI.BLA 60W C/R

REF A=7.34 REF B=11.18

60w



CLASSIC LUX

LAM-3174 REF C 21.67

PZA | LAMP.VAPOLETA EMPOTRAR.NEG 60W S/R

REF A=13.52 REF B=20.58

60w



CLASSIC LUX

LAM-3176 REF C 21.67

PZA | LAMP.VAPOLETA EMPOTRAR.BLA 60W S/R

REF A=13.52 REF B=20.58

100w



LAM-3190 REF C 26.59

PZA | VAPOLETA DE TECHO GRIS 100W S/BASE

REF A=16.6 REF B=25.26

100w



LAM-3192 REF C 26.59

PZA | VAPOLETA DE APLIQUE GRIS 100W S/BASE

REF A=16.6 REF B=25.26

60w



LAM-3194 REF C 22.44
PZA |VAPOLETA MORROCOY GRIS 60W

REF A=14.01 REF B=21.32



LAM-3202 REF C 4.12
PZA |VAPOLETA ## BASE SOLA GRIS

REF A=2.57 REF B=3.92



LAM-3209 REF C 3.86
PZA |VAPOLETA ## VIDRIO MORROCOY

REF A=2.41 REF B=3.67

2x17w



LAM-3290 REF C 22.26
PZA |LAMPAR HERMET.ANTIPOLVO 2X17W S/TUB

REF A=13.9 REF B=21.15

2x40w



LAM-3300 REF C 21.52
PZA |LAMPAR HERMET.ANTIPOLVO 2X40W S/TUB

REF A=13.44 REF B=20.45



LAM-5005 REF C 1.93
PZA |LAMPARA DE COMPAÑIA(NIÑOS)FLOR

REF A=1.2 REF B=1.83



LAM-5007 REF C 1.93
PZA |LAMPARA DE COMPAÑIA(NIÑOS)CORAZON

REF A=1.2 REF B=1.83



LAM-5009 REF C 1.93
PZA |LAMPARA DE COMPAÑIA(NIÑOS)MARIPOSA

REF A=1.2 REF B=1.83

4W



LAM-5013 REF C 1.95
PZA |LAMPARA COMPAÑIA(NIÑOS)MARIPOSA 344

REF A=1.22 REF B=1.86



40W



MHT-2008 REF C 28.09

PZA |CAUTIN 40W C/CONTROL TEMPERATUR.040

REF A=17.54 REF B=26.69



30W



MHT-2010 REF C 4.9

PZA |CAUTIN PUNTA FINA 30 W 110V IMP

REF A=3.06 REF B=4.65



40W



MHT-2013 REF C 4.24

PZA |CAUTIN PUNTA FINA 40W 110V SECURITY

REF A=2.65 REF B=4.03



3/8"



MHT-7486 REF C 1.7

PZA |GUARDACABO GALVZ. 3/8

REF A=1.06 REF B=1.61



1/8"



MHT-8836 REF C 0.24

PZA |PERRO P/GUAYA LIVIANO 1/8"

REF A=0.15 REF B=0.22



3/16"



MHT-8837 REF C 0.28

PZA |PERRO P/GUAYA LIVIANO 3/16"

REF A=0.18 REF B=0.27



1/4"



MHT-8838 REF C 0.31

PZA |PERRO P/GUAYA LIVIANO 1/4"

REF A=0.19 REF B=0.29



7/16"



MHT-8841 REF C 1.2

PZA |PERRO P/GUAYA LIVIANO 7/16"

REF A=0.75 REF B=1.14



7/8"

MHT-8845 REF C 4.17

PZA |PERRO P/GUAYA LIVIANO 7/8 "

REF A=2.6 REF B=3.96



127Pcs

MHT-9017 REF C 3.16
**KIT | KIT TERMOENCOGIBLE SURT.Q7-
 HS127PZA**

REF A=1.97 REF B=3



127Pcs

MHT-9018 REF C 3.16
**KIT | KIT TERMOENCOGIBLE SURTIDOS 127
 PZA**

REF A=1.97 REF B=3



127pcs

MHT-9019 REF C 2.51
**KIT | KIT TERMOENCOGIB.SURTID.127P.VOL
 TSHT**

REF A=1.57 REF B=2.39



3/4x20MTS

MHT-9235 REF C 25.67
**PZA | TEIPE ELECT.SUPER 3M N33
 3/4X20MTS**

REF A=16.02 REF B=24.39



3/4

MHT-9236 REF C 1.59
RLL | TEIPE ELE.COBRAS U.S.A 3/4X60FT GRD

REF A=0.99 REF B=1.51



3/4"x18M

MHT-9242 REF C 2.9
**RLL | TEIPE ELE.COBRAS 3/4 X 60FT
 AMARILLO**

REF A=1.81 REF B=2.75



3/4"x18M

MHT-9243 REF C 2.9
RLL | TEIPE ELE.COBRAS 3/4 X 60FT BLANCO

REF A=1.81 REF B=2.75



3/4"x18M

MHT-9244 REF C 2.9
RLL | TEIPE ELE.COBRAS 3/4 X 60FT AZUL

REF A=1.81 REF B=2.75



3/4"x18M

MHT-9246 REF C 3.01
RLL | TEIPE ELE.COBRAS 3/4 X 60FT ROJO

REF A=1.88 REF B=2.86



**3/4"66FT
22YN**

MHT-9250 REF C 1.12
RLL | TEIPE ELEC.TIPO COBRA 3/4"66FT
22YN
REF A=0.7 REF B=1.07



**10mm
x100 M**

Voltage
electronics part

MHT-9430 REF C 21.46
RLL | TERMOENCOGIBLE 10MM X 100 MTS
VOLTG
REF A=13.39 REF B=20.38



**12mm
x100 M**

Voltage
electronics part

MHT-9435 REF C 21.78
RLL | TERMOENCOGIBLE 12MM X 100 MTS
VOLTG
REF A=13.59 REF B=20.69



6-12-24V

DIESEL TOOLS

MRA-6001 REF C 7.36
PZA | PROBAD.6-12-24V HD.CABL/
ESPIR.JT001
REF A=4.59 REF B=6.99



**TESTER PARA
CIRCUITO CERRADO
O ABIERTO**

DIESEL TOOLS

MRA-6005 REF C 2.68
PZA | PROBAD.DE CONTINUIDAD D/
BATERIA.851
REF A=1.67 REF B=2.54



6 y 12V

DIESEL TOOLS

MRA-6010 REF C 31.49
PZA | PROBADOR D/CARGA BATERIA 6 Y
12V DIE
REF A=19.66 REF B=29.92



60cm

DIESEL TOOLS

MRA-6200 REF C 1.58
PZA | RECOJEDOR MAGNETIC.FLEXIBL.60CM
025
REF A=0.99 REF B=1.5



Exceline

MRA-6890 REF C 13.3
KIT | TERMINAL P/BREAK.IND
EXCEL.BRE-5890
REF A=8.3 REF B=12.63



**40x40
mm**

MTR-0700 REF C 1.58
PQT | BASE P/AMARRA CABLE 40X40MM
PQT100
REF A=0.99 REF B=1.5

**4" x
2.5mm**



MTR-6002 REF C 0.48
PQT |CINTA AMARRE BLANC
100mm(4")x2.5mm
REF A=0.3 REF B=0.46

2.5x150mm



MTR-6004 REF C 0.62
PQT |CINTA AMARRE BLANC
150mm(6")x2.5mm
REF A=0.38 REF B=0.58

**8" x
2.5mm**



MTR-6006 REF C 1.26
PQT |CINTA AMARRE BLANC
200mm(8")x2.5mm
REF A=0.78 REF B=1.19

**6" x
3.6mm**



MTR-7144 REF C 1.12
PQT |CINTA AMARRE BLANC
150mm(6")x3.6mm
REF A=0.7 REF B=1.07

**8" x
3.6mm**

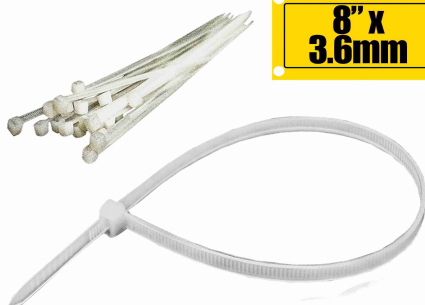

MTR-7146 REF C 1.44
PQT |CINTA AMARRE BLANC
200mm(8")x3.6mm
REF A=0.9 REF B=1.37

**10" x
3.6mm**



MTR-7148 REF C 2.04
PQT |CINTA AMARRE BLANC
250mm(10")x3.6mm
REF A=1.27 REF B=1.94

**12" x
3.6mm**



MTR-7150 REF C 2.03
PQT |CINTA AMARRE BLANC
300mm(12")x3.6mm
REF A=1.27 REF B=1.93

**10" x
4.8mm**



MTR-7308 REF C 2.19
PQT |CINTA AMARRE BLANC
250mm(10")x4.8mm
REF A=1.37 REF B=2.08

**12" x
4.8mm**



MTR-7310 REF C 2.73
PQT |CINTA AMARRE BLANC
300mm(12")x4.8mm
REF A=1.7 REF B=2.59

**14"
x4.8MM**



MTR-7312 REF C 3.16

PQT |CINTA AMARRE BLANC
350mm(14")x4.8mm

REF A=1.97 REF B=3

**4.8x400
mm**



MTR-7314 REF C 3.85

PQT |CINTA AMARRE BLANC
400mm(16")x4.8mm

REF A=2.4 REF B=3.66

**8x
450mm**



MTR-7316 REF C 5.35

PQT |CINTA AMARRE BLANC
450mm(18")x4.8mm

REF A=3.34 REF B=5.08

**20"
x4.8mm**



MTR-7318 REF C 5.83

PQT |CINTA AMARRE BLANC
500mm(20")x4.8mm

REF A=3.64 REF B=5.54

**20"
x7mm**



MTR-7388 REF C 6.96

PQT |CINT.AMAR.BLAN.500mm 20"x7.0m
P/50

REF A=4.34 REF B=6.61

**14"
x7.6MM**



MTR-7422 REF C 6.96

PQT |CINTA AMARRE BLANC
350mm(14")x7.6mm

REF A=4.34 REF B=6.61

**16"
x7.6MM**



MTR-7424 REF C 7.87

PQT |CINTA AMARRE BLANC
400mm(16")x7.6mm

REF A=4.91 REF B=7.47

**6x
450mm**



MTR-7426 REF C 9.44

PQT |CINTA AMARRE BLANC
450mm(18")x7.6mm

REF A=5.9 REF B=8.97

**8x250
mm**



MTR-7458 REF C 4.57

PQT |CINTA AMARRE BLANC
250mm(10")x8.0mm

REF A=2.86 REF B=4.35



**8x300
mm**



MTR-7460 REF C 4.9
PQT |CINTA AMARRE BLANC
300mm(12")x8.0mm
REF A=3.06 REF B=4.65



**8mm
x450mm**



MTR-7466 REF C 6.63
PQT |CINTA AMARRE BLANC
450mm(18")x8.0mm
REF A=4.14 REF B=6.3

**26"
x9mm**

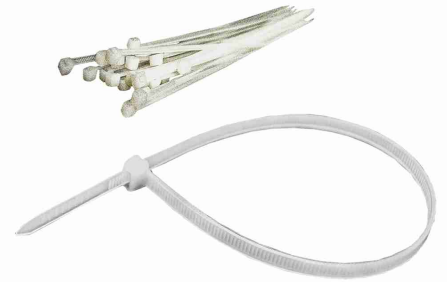

MTR-7489 REF C 47.12
PQT |CINTA AMARRE BLANC
650mm(26")x9.0mm
REF A=29.41 REF B=44.77

**30"
x9mm**

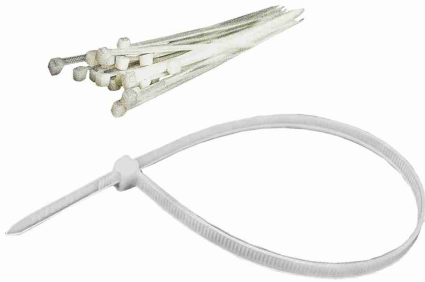

MTR-7491 REF C 38.95
PQT |CINTA AMARRE BLANC
760mm(30")x9.0mm
REF A=24.31 REF B=37



**2.5mm
x450mm**



MTR-7502 REF C 0.48
PQT |CINTA AMARRE NEGRO
100mm(4")x2.5mm
REF A=0.3 REF B=0.46

**6"
x2.5mm**



MTR-7504 REF C 0.62
PQT |CINTA AMARRE NEGRO
150mm(6")x2.5mm
REF A=0.38 REF B=0.58

**8" x
2.5mm**



MTR-7506 REF C 1.26
PQT |CINTA AMARRE NEGRO
200mm(8")x2.5mm
REF A=0.78 REF B=1.19

**6"
x3.6mm**



MTR-7644 REF C 1.12
PQT |CINTA AMARRE NEGRO
150mm(6")x3.6mm
REF A=0.7 REF B=1.07

**8" x
3.6mm**



MTR-7646 REF C 1.44
PQT |CINTA AMARRE NEGRO
200mm(8")x3.6mm
REF A=0.9 REF B=1.37

10" x3.6MM



MTR-7648 REF C 1.74
PQT |CINTA AMARRE NEGRO
250mm(10")x3.6mm
REF A=1.09 REF B=1.65

12" x 3.6m



MTR-7650 REF C 2.03
PQT |CINTA AMARRE NEGRO
300mm(12")x3.6mm
REF A=1.27 REF B=1.93

18" x 4.2m



MTR-7716 REF C 7.09
PQT |CINTA AMARRE NEGRO
450mm(18")x4.2mm
REF A=4.43 REF B=6.74



4.5mm x200mm



MTR-7786 REF C 2.03
PQT |CINTA AMARRE NEGRO
200mm(8")x4.5mm
REF A=1.27 REF B=1.93

10" x4.8MM



MTR-7838 REF C 2.19
PQT |CINTA AMARRE NEGRO
250mm(10")x4.8mm
REF A=1.37 REF B=2.08

12" x 4.8m



MTR-7840 REF C 2.73
PQT |CINTA AMARRE NEGRO
300mm(12")x4.8mm
REF A=1.7 REF B=2.59

14" x4.8MM



MTR-7842 REF C 3.16
PQT |CINTA AMARRE NEGRO
350mm(14")x4.8mm
REF A=1.97 REF B=3

16" x4.8mm



MTR-7844 REF C 3.85
PQT |CINTA AMARRE NEGRO
400mm(16")x4.8mm
REF A=2.4 REF B=3.66

20" x4.8mm



MTR-7848 REF C 5.83
PQT |CINTA AMARRE NEGRO
500mm(20")x4.8mm
REF A=3.64 REF B=5.54

14" x
7.7m



MTR-8062 REF C 6.96
PQT |CINTA AMARRE NEGRO
350mm(14")x7.6mm
REF A=4.34 REF B=6.61

6x
450mm



MTR-8066 REF C 9.44
PQT |CINTA AMARRE NEGRO
450mm(18")x7.6mm
REF A=5.9 REF B=8.97

8mm
x250mm



MTR-8108 REF C 4.74
PQT |CINTA AMARRE NEGRO
250mm(10")x8.0mm
REF A=2.96 REF B=4.5

8mm
x350mm



MTR-8112 REF C 2.84
PQT |CINTA AMARRE NEGRO
350mm(14")x8.0mm
REF A=1.77 REF B=2.69

18"
x8MM



MTR-8116 REF C 7.87
PQT |CINTA AMARRE NEGRO
450mm(18")x8.0mm
REF A=4.91 REF B=7.47

8mm
x500mm



MTR-8118 REF C 8.83
PQT |CINTA AMARRE NEGRO
500mm(20")x8.0mm
REF A=5.51 REF B=8.39

E-10
3A 250V



SOC-0968 REF C 0.66
PZA |SOCATE PORCELA.SUPER.E-10 3A 250V
REF A=0.41 REF B=0.63

E-27

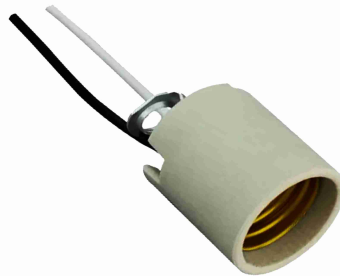

SOC-0995 REF C 0.57
PZA |SOCATE PORCELANA E-27 P/NIPLE
REF A=0.35 REF B=0.54

E-27



SOC-1020 REF C 0.4
PZA |SOCATE PORCELANA E-27 2PZA CHINO
REF A=0.25 REF B=0.38



E-27

SOC-1030 REF C 2.19
PZA |SOCATE PORCELANA IND E-27 PR1

REF A=1.37 REF B=2.08



E-40

SOC-1040 REF C 1.95
PZA |SOCATE PORCELANA IND E-40 PR4

REF A=1.22 REF B=1.86



E-27

SOC-1045 REF C 0.4
PZA |SOCATE PORC.BASE CUADRA.D/TOR E-27

REF A=0.25 REF B=0.38



E-27

SOC-1055 REF C 5.37
PZA |SOCATE PORCELANA BASE SUPERF.E-27

REF A=3.35 REF B=5.1



E-40

SOC-1057 REF C 6.12
PZA |SOCATE PORCELANA BASE SUPERF.E-40

REF A=3.82 REF B=5.82



15A-600V E-40

SOC-1060 REF C 1.72
PZA |SOCATE PORCELANA CON CABLE E-40

REF A=1.07 REF B=1.63



E-27aE-40 362 T/E

SOC-1100 REF C 1.91
PZA |SOCAT.CONV/EXPAN.E-27AE-40 362 T/E

REF A=1.19 REF B=1.81



40E-27E

SOC-1105 REF C 0.78
PZA |SOCAT.CONV/EXPAN.E-40AE-27 332 T/E

REF A=0.48 REF B=0.74



E-27

SOC-2000 REF C 0.68
PZA |SOCATE PORC. E-27 TOPE P/OJO BUEY

REF A=0.43 REF B=0.65

20W



SOC-2054 REF C 4.17
PZA |SOCATE REPUESTO P/
LAMP.ELECTR.20W
REF A=2.6 REF B=3.96

E-27



Voltage
electronicspart

SOC-2070 REF C 0.54
PZA |SOCATE E-27 BAK.C/MACHO T/EA
738 VOL
REF A=0.33 REF B=0.51

E-27



SOC-2085 REF C 0.71
PZA |SOCATE BAQUELITA C/CADEN E-27
F136
REF A=0.44 REF B=0.67



SOC-2103 REF C 0.54
PZA |SOCATE GOMA NEGRO REFORZADO C/
LENG
REF A=0.33 REF B=0.51

**15A-125V
E-27**



SOC-2104 REF C 0.38
PZA |SOCATE GOMA/INTERIOR
PORCELAN.E-27
REF A=0.24 REF B=0.36

1200A



SOC-2111 REF C 0.52
PZA |SOCATE FLUORESCEN.SENCILLO
G/1200A
REF A=0.32 REF B=0.49

4S-G104



SOC-2112 REF C 0.61
PZA |SOCATE FLUOR.SENC.SEGURID.4S-
G104
REF A=0.38 REF B=0.58



SOC-2115 REF C 0.37
PZA |SOCATE FLUORESCENTE C/PORTA
STARTE
REF A=0.23 REF B=0.35



SOC-2116 REF C 1.77
JGO |SOCATE FLOUR.SLIM LINE LIV.IMP JGO
REF A=1.1 REF B=1.68

150W/78M



SOC-2118 REF C 1.25
PZA |SOCATE P/REFLECTOR
HALOG.150W/78M
REF A=0.78 REF B=1.18

**1500W
254M**

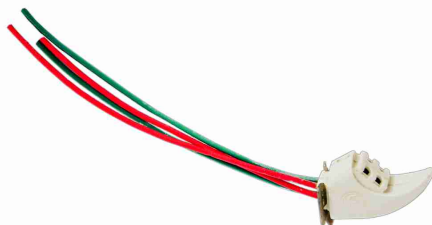

SOC-2120 REF C 0.19
PZA |SOCATE PICO LORO C/UYA
REF A=0.12 REF B=0.18



SOC-2121 REF C 1.89
PZA |SOCATE P/
REFLECTO.HALOG.1500W/254M
REF A=1.18 REF B=1.8

500W

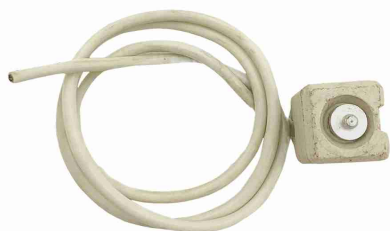

SOC-2122 REF C 2.64
PZA |SOCATE HALOGENO 500W P/REFLEC
LEGA
REF A=1.65 REF B=2.51

**300A
1500W**



SOC-2125 REF C 2.54
PZA |SOCATE HALOGEN D/RESORT.300A
1500W
REF A=1.58 REF B=2.41

1500W



SOC-2126 REF C 3.23
PZA |SOCATE HALOGENO 1500W P/REFLEC
LEGA
REF A=2.01 REF B=3.07

**GU10-2Amp
250v**



SOC-2132 REF C 0.41
PZA |SOCATE HALOG.REDEN.GU10 P/
DICROICO
REF A=0.28 REF B=0.39

MS-G128



SOC-2140 REF C 0.57
PAR |SOCATE P/LAMPARA ESPECULAR MS-
G128
REF A=0.35 REF B=0.54

E-27-110



SOC-2248 REF C 3.65
PZA |SOC:ADAPTADO E-27 C/TUB 32 110
FM
REF A=2.28 REF B=3.47

32W E-27



SOC-2258 REF C 4.47
PZA |SOCATE-ADAPT.P/LAM.CIR.32W E-27
FM
REF A=2.79 REF B=4.25

E-14



SOC-2278 REF C 0.52
PZA |SOC MIŞON NEG.E-14 UREA/
FENOL.S114
REF A=0.32 REF B=0.49

E-27



SOC-2288 REF C 0.52
PZA |SOCA.MIŞON NEG.E-27 UREA/
FENOL.S127
REF A=0.32 REF B=0.49

E-27



SOC-2290 REF C 3.3
PZA |SOCATE EDISON E-27 BAKELIT.NEG ITA
REF A=2.06 REF B=3.13

E-27



SOC-2291 REF C 1.65
PZA |SOCATE EDISON E-27 BAKELIT BLAN
ITA
REF A=1.03 REF B=1.57

E-27



SOC-2301 REF C 4
PZA |SOC.ALEM.BAK.E-27 C/ROS/
ANIL.BLA.ITA
REF A=2.5 REF B=3.8

**100W
200-500°C**



TOT-0200 REF C 12.16
PZA |CAUTIN 100WT 120V 500°C TOTAL
831
REF A=7.59 REF B=11.56