



CATÁLOGO DE **PRODUCTOS**

AUTOMOTRIZ



Gr 280

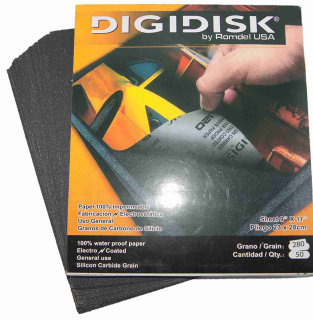

DIGIDISK

ABR-0280 REF C 27.23
PQT |LIJA PREMIER GRANO 280. CARBO/
DIGID
REF A=17 REF B=25.87

Gr 320

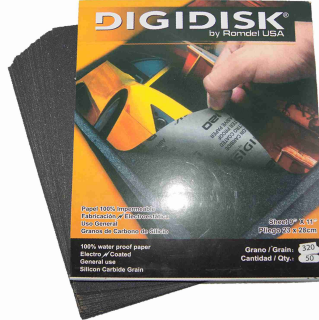

DIGIDISK

ABR-0320 REF C 27.23
PQT |LIJA PREMIER GRANO 320. CARBO/
DIGID
REF A=17 REF B=25.87

Gr 240



ZASC

ABR-0780 REF C 5.62
PQT |LIJA AGUA IMPERMEAB.ZASC #240
25PZA
REF A=3.51 REF B=5.34

Gr 280



ZASC

ABR-0785 REF C 5.62
PQT |LIJA AGUA IMPERBEAB.ZASC #280
25PZA
REF A=3.51 REF B=5.34

Gr 320



ZASC

ABR-0790 REF C 5.62
PQT |LIJA AGUA IMPERMEAB.ZASC #320
25PZA
REF A=3.51 REF B=5.34

Gr 360



ZASC

ABR-0795 REF C 5.62
PQT |LIJA AGUA IMPERMEAB.ZASC #360
25PZA
REF A=3.51 REF B=5.34

Gr 400



ZASC

ABR-0800 REF C 5.62
PQT |LIJA AGUA IMPERMEAB.ZASC #400
25PZA
REF A=3.51 REF B=5.34

Gr 600



ZASC

ABR-0840 REF C 5.62
PQT |LIJA AGUA IMPERMEAB.ZASC #600
25PZA
REF A=3.51 REF B=5.34

Gr 100



DIESEL TOOLS

ABR-0853 REF C 9.44
PQT |LIJA AGUA CASTOR/DISEL TOOL
GR#100
REF A=5.9 REF B=8.97



120gr



ABR-0856 REF C 9.79
PQT |LIJA AGUA DIESEL TOOLS GRANO # 120
REF A=6.11 REF B=9.3



Gr 180



ABR-0861 REF C 9.44
PQT |LIJA AGUA SPEED/DIESEL TOOLS GR#180
REF A=5.9 REF B=8.97



#220



ABR-0863 REF C 11.26
PQT |LIJA AGUA SPEED/DIESEL TOOLS GR#220
REF A=7.03 REF B=10.7



Gr 180



ABR-0915 REF C 96.89
PQT |LIJA AL AGUA 3M SERIE 431Q GR 180
REF A=60.48 REF B=92.05



4.1/2"



ABR-2150 REF C 5.67
PZA |DISC.POLICARB.4.5"REMOVEDOR PINT Q7
REF A=3.54 REF B=5.39



4.1/2"



ABR-2155 REF C 6.93
PZA |DISC.POLICARB.PREMIU.4.5"REMOV.PIN T
REF A=4.33 REF B=6.58



7"-Gr 60



ABR-3060 REF C 1.08
PZA |FIBRO DISCO FLEXIBLE 7 GR # 60.IMP
REF A=0.67 REF B=1.02



5/8" 11-20mm



ABZ-1010 REF C 0.38
PZA |ABRAZ.INOXID.C/TORN INOX.5/8 11-20M
REF A=0.24 REF B=0.36



1/2"-3/4" 13-19mm



ABZ-1015 REF C 2.22
PQT |ABRAZ.INOX.13-19M 1/2-3/4 PQ10 HC34
REF A=1.39 REF B=2.11

1"
20-30mm



ABZ-1025 REF C 0.54
PZA | ABRAZ.INOXID.C/TORN.INOX.1
20-32M.
REF A=0.34 REF B=0.51



3/4x1.3/4"
19-44mm



ZASC

ABZ-1035 REF C 4.66
PQT | ABRAZ.INOX.19-44M 3/4-1.3/4 P10
134
REF A=2.91 REF B=4.42



3/8"
6-10mm



Wolfgang

ABZ-2310 REF C 0.08
PZA | ABRAZADERA GALVZ S/F
3/8"6-10mmIMP.
REF A=0.05 REF B=0.08



3/8" - 6-10mm
PQT 50 PZAS



Q7

ABZ-2312 REF C 4.74
PQT | ABRAZAD.GALVZ S/F 3/8"6-10m
PQT-50P
REF A=2.96 REF B=4.5



1/2"
11-20mm



Wolfgang

ABZ-2320 REF C 0.11
PZA | ABRAZADERA GALVZ S/F 1/2"
11-20mIMP
REF A=0.07 REF B=0.11



5/8" - 10-16mm
PQT 50 PZAS



Q7

ABZ-2323 REF C 5.06
PQT | ABRAZAD.GALVZ S/F 5/8"10-16m
PQT50PZ
REF A=3.16 REF B=4.8



5/8"
12-25m



DIESEL TOOLS

ABZ-2330 REF C 0.14
PZA | ABRAZADERA GALVZ S/F 5/8"12-25m
IMP
REF A=0.09 REF B=0.14



3/4"
13-19m



Wolfgang

ABZ-2360 REF C 0.18
PZA | ABRAZADERA GALVZ S/F 3/4"13-19m
IMP
REF A=0.11 REF B=0.17



7/8"
20-31mm



DIESEL TOOLS

ABZ-2361 REF C 0.21
PZA | ABRAZADERA GALVZ S/F 7/8"20-31m
IMP
REF A=0.13 REF B=0.2

1.1/2"
21-38mm

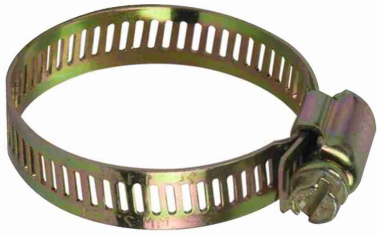

ABZ-2363 REF C 0.27
PZA | ABRAZADERA GALVZ S/F 1.1/2
21-38MM

REF A=0.17 REF B=0.26

20-40mm

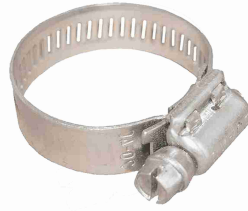

ABZ-3204 REF C 1.77
PZA | ABRAZADERA GALVZ.ANCHA H.D
20-40MM

REF A=1.1 REF B=1.68

60-80mm



ABZ-3212 REF C 2.24
PZA | ABRAZADERA GALVZ.ANCHA H.D
60-80MM

REF A=1.4 REF B=2.13

120-140
mm



ABZ-3224 REF C 3.04
PZA | ABRAZADER.GALVZ.ANCHA H.D
120-140M

REF A=1.9 REF B=2.89

44-47mm



ABZ-3391 REF C 0.86
PZA | ABRAZADER.EXTR.FUERT.C/
TOR.44-47M

REF A=0.82 REF B=0.91

188-200
mm



ABZ-3451 REF C 12.8
PZA | ABRAZADER.EXTR.FUERT.C/
TOR.188-200

REF A=7.99 REF B=12.16

14 AWG
100% COBRE



CBL-0700 REF C 46.45
RLL | CABLE THHH 14 TRENZ.105\$ BLANC
VOLT

REF A=28.99 REF B=44.13

14AWG
100% COBRE



CBL-0710 REF C 46.45
RLL | CABLE THHN 14 TRENZ.105\$ ROJO
VOLTG

REF A=28.99 REF B=44.13

14AWG
100% COBRE



CBL-0715 REF C 46.45
RLL | CABLE THHN 14 TRENZ.105\$ AZUL
VOLTG

REF A=28.99 REF B=44.13



12AWG
100% COBRE



Voltage
electronics part 100% COBRE / 100% COPPER

CBL-0742 REF C 71.47
RLL | CABLE THHN 12 TRENZ.105\$ ROJO
VOLTG
REF A=44.62 REF B=67.91



12AWG
100% COBRE



Voltage
electronics part 100% COBRE / 100% COPPER

CBL-0747 REF C 71.47
RLL | CABLE THHN 12 TRENZ.105\$ AZUL
VOLTG
REF A=44.62 REF B=67.91



10 AWG
100% COBRE



Voltage
electronics part 100% COBRE / 100% COPPER

CBL-0772 REF C 124.82
RLL | CABLE THHN 10 TRENZ.105\$ ROJO
VOLTG
REF A=77.92 REF B=118.59



10 AWG
100% COBRE



Voltage
electronics part 100% COBRE / 100% COPPER

CBL-0782 REF C 124.82
RLL | CABLE THHN 10 TRENZ.105\$
AMARI.VOLT
REF A=77.92 REF B=118.59



10 AWG
100% COBRE



Voltage
electronics part 100% COBRE / 100% COPPER

CBL-0787 REF C 124.82
RLL | CABLE THHN 10 TRENZ.105\$ VERDE
VOLT
REF A=77.92 REF B=118.59



2x20 AWG
100 M



DIESEL TOOLS

CBL-2065 REF C 18.94
RLL | CABLE CORNETA 2X20 ROJO/NEGRO
100MT
REF A=11.82 REF B=18



2x18 AWG
100 M



DIESEL TOOLS

CBL-2070 REF C 28.57
RLL | CABLE CORNETA 2X18 ROJO/NEGRO
100MT
REF A=17.84 REF B=27.15



V-TEG

LAM-1595 REF C 13.38
PZA | LAMPARA LED EMERGENCIA TRABAJO
VTEG
REF A=8.35 REF B=12.71



20x10CM



**Wash & Dry
Sponge**

LIM-0820 REF C 2.14
PZA | ESPONJA MICROFIBRA AUTO 20X10CM
769
REF A=1.34 REF B=2.03



15x20cm

LIM-5045 REF C 1.42
PQT | PAÑOS HUMED. MULTIFUNC. 15X20C
PQ30-33
REF A=0.89 REF B=1.35



15x20cm

LIM-5051 REF C 1.74
PQT | PAÑOS HUMED. P/CARRO 15X20C
PQ40-725
REF A=1.09 REF B=1.65



15x20cm

LIM-5053 REF C 2.51
PQT | PAÑOS HUMEDO P/CARRO C/TA
PQ80-45
REF A=1.57 REF B=2.39



**3/8"-200PSI
60MTS**

MAG-6054 REF C 6.97
MTS | MANG. PRE/AIR-H2O 3/8USA
200PSIC/60M
REF A=4.35 REF B=6.62



1/4"

MHT-0196 REF C 3.85
KIT | ADAPTAD.ACOPL.RAP.MANG/AIRE 5P
DIES
REF A=2.4 REF B=3.66



5PCS

MHT-0198 REF C 4.74
KIT | ADAPTAD.ACOPL.RAP.MANG/AIRE 5P
MAXT
REF A=2.96 REF B=4.5



1/4"-6PCS

MHT-0200 REF C 5.99
KIT | ADAPTAD.ACOPL RAP.P/MANG.AIRE
5PZ F
REF A=3.74 REF B=5.69



1/4"

MHT-0210 REF C 6.42
SET | ADAPTAD.DADO P/TALADR.6PZ 1/4-
WH006
REF A=4.01 REF B=6.1



**1/4"-3/8"
1/2"**

MHT-0228 REF C 3
JGO | ADAPTADOR DADO 4P 1/4-3/8-1/2
1022
REF A=1.87 REF B=2.85



1/4"-3/8"
1/2"

Q7

MHT-0230 REF C 3.48
JGO | ADAPTADOR DADO JGO 4P
1/4-3/8-1/2Q7
REF A=2.17 REF B=3.3



1/4"-3/8"
1/2"-3/4"

DIESEL TOOLS

MHT-0233 REF C 14.69
JGO | ADAPTAD.DADO JG6 1/4-3/8-1/2-3/4
DS
REF A=9.17 REF B=13.95



7 PCS
1/4"-3/8"-1/2"

DIESEL TOOLS

MHT-0234 REF C 13.06
JGO | ADAPTAD+CARDAN.SET 7 PC
UNIVERS.004
REF A=8.15 REF B=12.4



8PCS

DIESEL TOOLS

MHT-0236 REF C 27.74
JGO | ADAPTAD.DAD.IMPACTO 8P 1/4 A
1"D008
REF A=17.32 REF B=26.36



500cc

DIESEL TOOLS

MHT-0435 REF C 5.81
PZA | ACEITERA P/FLEXIBLE 500CC DIESEL
TO
REF A=3.63 REF B=5.52



1.5HP-1 GAL
60HZ-110V

ELITE

MHT-0585 REF C 102.99
PZA | ASPIRADO.HUM/SEC 1.5HP 3.8 LTS
ELIT
REF A=64.29 REF B=97.85



20L
1100W

Jadever

MHT-0691 REF C 104.45
PZA | ASPIRADO.HUM/SEC 1100W 20 LTS
R2A20
REF A=65.2 REF B=99.23



25L
1100W

Jadever

MHT-0692 REF C 104.45
PZA | ASPIRADO.HUM/SEC 1100W 25 LTS
R4A25
REF A=65.2 REF B=99.23



1.2P 30LTS

FERMETAL

MHT-0693 REF C 171.54
PZA | ASPIRADO.HUM/SEC 1.2P 30 LTS FERM
REF A=107.08 REF B=162.97



30L
1100W



Jadever

MHT-0695 REF C 114.24
PZA |ASPIRADO.HUM/SEC 1100W 30 LTS
R2A30
REF A=71.31 REF B=108.53



30 L
1100W



Jadever

MHT-0697 REF C 124.03
PZA |ASPIRADO.HUM/SEC 1100W 30 LTS
R4A30
REF A=77.42 REF B=117.84



16GAL



RIDGID

MHT-0706 REF C 630.09
PZA |ASPIRADORA IND.SEC/HUM RIDGID
16GAL
REF A=393.31 REF B=598.62

5"



MHT-1002 REF C 1.39
PZA |ALICT.PINZA CURVA 5"M/GOMA P/
BISUTER.
REF A=0.87 REF B=1.32

5"



MHT-1004 REF C 1.39
PZA |ALICT.PINZA PLANA 5"M/GOMA P/
BISUTER.
REF A=0.87 REF B=1.32

4.1/2"
4 PIEZAS



DIESEL TOOLS

MHT-1015 REF C 9.15
SET |ALICATE 4.1/2" MINI JGO
4Pz.DS10404
REF A=5.71 REF B=8.69



6" PINZA
PIQUETA
ALICATE



CROWNMAN

MHT-1020 REF C 16.69
PZA |ALICATES JGO.3P PIN 6-PIQ 6-ALI
8CROW
REF A=10.42 REF B=15.86

SACABOCADO
6 PUNTAS



URSO

MHT-1069 REF C 8.19
PZA |ALICATE SACABOCADO 6 PUNTAS
REF A=5.11 REF B=7.78

6"



DIESEL TOOLS

MHT-1072 REF C 3
PZA |ALICATE MECANICO COMB.PESD/
FORRAD 6"
REF A=1.87 REF B=2.85



8"



MHT-1074 REF C 5.19
PZA |ALICATE MECANICO COMB.CROM. 8"

REF A=3.24 REF B=4.93



10"



MHT-1078 REF C 5.67
PZA |ALICATE MECANICO COMBIN.CROM. 10"

REF A=3.54 REF B=5.39



10"



MHT-1079 REF C 5.67
PZA |ALICATE MECANICO COMB.CRO/
FORRA.10

REF A=3.54 REF B=5.39



7"



MHT-1082 REF C 4.09
PZA |ALICAT.PINZ.7"SACA RETEN CERRAR
REC

REF A=2.56 REF B=3.89



7"



MHT-1083 REF C 4.39
PZA |ALIC.PINZA.7"SACA RETEN CERRAR
CURV

REF A=2.74 REF B=4.17

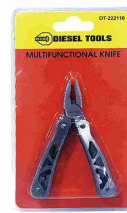

4.1/2"



MHT-1086 REF C 7.09
PZA |ALICATE PINZA MULTIUSO
4.1/2"DS2116

REF A=4.43 REF B=6.74



19 EN 1



MHT-1087 REF C 12.04
PZA |ALIC.PINZA MULTIUSO 6.1/2"19EN1
269

REF A=7.52 REF B=11.44



8"



MHT-1089 REF C 5.18
PZA |ALICATE PINZA PIC RECTO M/GOM 8
WQ

REF A=3.23 REF B=4.92



7"



MHT-1093 REF C 16.99
JGO |ALICATE SACA RETEN 7"JGO 4PCS Q7

REF A=10.6 REF B=16.14



MHT-1095 REF C 7.7
 JGO |ALICATE PINZA SACA RETEN 4PUNTAS Q7
 REF A=4.81 REF B=7.32



MHT-1099 REF C 4.74
 PZA |ALICATE CORTE DIAGONAL 8" DIESEL D8
 REF A=2.96 REF B=4.5



MHT-1104 REF C 8.22
 PZA |ALICATE DE PRESION ECONOM.DE 10"DT
 REF A=5.13 REF B=7.81



MHT-1106 REF C 29.35
 PZA |ALICATE DE PRESION DE 10" VISE-GRIP
 REF A=18.32 REF B=27.88



MHT-1108 REF C 7.52
 PZA |ALICATE PRESION RECT.10 M/GOM DIES
 REF A=4.69 REF B=7.14



MHT-1156 REF C 3.53
 PAR |BORNES ALUMINIO + Y - P/CARRO JGO
 REF A=2.21 REF B=3.36



MHT-1160 REF C 4.12
 PZA |BORNES D/PLOMO P/CARRO
 REF A=2.57 REF B=3.92



MHT-1161 REF C 12.65
 SET |BORNES D/PLOMO CARRO PQT 10PZ DIESEL
 REF A=7.89 REF B=12.01



MHT-1162 REF C 4.71
 PAR |BORNES BRONC CARR ACODAD.(+)-2Pz
 REF A=2.94 REF B=4.47



MHT-1163 REF C 2.73
 PZA | BORNES D/PLOMO MARIPOSA
 POSITIVO
 REF A=1.71 REF B=2.6



MHT-1164 REF C 2.73
 PZA | BORNES D/PLOMO MARIPOSA
 NEGATIVO
 REF A=1.71 REF B=2.6

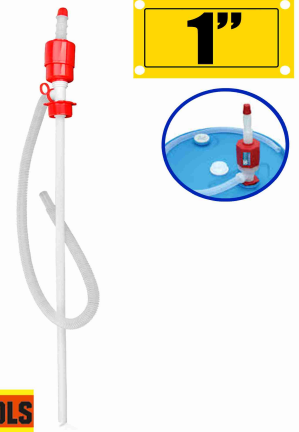

MHT-1260 REF C 5.3
 PZA | BOMBA P/TAMBOR PLASTICA 1" DS-
 S210
 REF A=3.31 REF B=5.03



MHT-1264 REF C 39.17
 PZA | BOMB.TAMBOR MET.ACEIT.15L/MIN
 2515
 REF A=24.45 REF B=37.21



MHT-1265 REF C 58.05
 PZA | BT-25 BOMBA PARA TAMBOR
 ROTATIVA 1"
 REF A=36.23 REF B=55.15



MHT-1730 REF C 270.9
 PZA | CARRO HERRAMIENTAS 4
 TRAM.96X66X30
 REF A=169.1 REF B=257.38



MHT-2363 REF C 11.95
 PZA | CUERDA DE ARRASTRE 3TON X4MM
 CROWNMAN
 REF A=7.46 REF B=11.35



MHT-2365 REF C 5.06
 PQT | CUERDA ELAST.18/24/32/40"x8MM
 8PZA
 REF A=3.16 REF B=4.8



MHT-2366 REF C 2.51
 PAR | CUERDA ELASTICA 8MMX80CM
 CROWNMAN
 REF A=1.57 REF B=2.39





**12x180
cm**



MHT-2370 REF C 3.77
PZA | CUERDA ELASTICA 12MMX180CM
CROWNMAN

REF A=2.35 REF B=3.58



36"



MHT-2389 REF C 1.93
PZA | CUERDA ELASTICA 36"

REF A=1.2 REF B=1.83



**3"
53-157mm**

MHT-2494 REF C 6.29
PZA | COMPRESOR P/ANILLO PISTON
3"53-175MM

REF A=3.92 REF B=5.97



**4"
53-157mm**

MHT-2495 REF C 7.09
PZA | COMPRESOR P/ANILLO PISTON
4"53-175MM

REF A=4.43 REF B=6.74



**6"
60-195mm**

MHT-2496 REF C 11.43
PZA | COMPRESOR P/ANILLO PISTON
6"60-195MM

REF A=7.13 REF B=10.86



3"



MHT-2497 REF C 5.3
PZA | COMPRESOR P/ANILLO PISTON
3"D-303A3

REF A=3.31 REF B=5.03



4"

MHT-2498 REF C 6.26
PZA | COMPRESOR P/ANILLO PISTON
4"DS303A4

REF A=3.91 REF B=5.95



6"

MHT-2499 REF C 10.96
PZA | COMPRESOR P/ANILLO PISTON
6"D-303A6

REF A=6.84 REF B=10.41



5/16"



MHT-2914 REF C 3.48
KIT | DADO MAGNETI.5/16 P/
TORN.TECH.5P Q7

REF A=2.17 REF B=3.3

12PCS



MHT-2950 REF C 28.36
PZA | DADO TARRAJA JGO 12PCS
CROWNMAN
REF A=17.7 REF B=26.94



**12P
3-12mm**

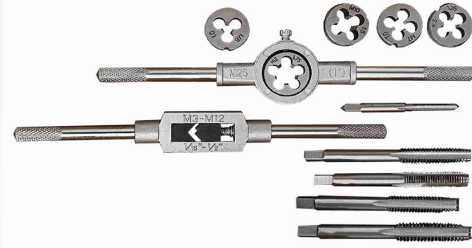

MHT-2952 REF C 13.86
SET | DADO TARRAJA Y MACHO JGO 12P
3-12MM
REF A=8.65 REF B=13.17



4.1/2"



MHT-4433 REF C 2.22
PZA | DIS. 4.1/2" CORT. HUM. CONTINUO
WID. WOL
REF A=1.39 REF B=2.11

400cc

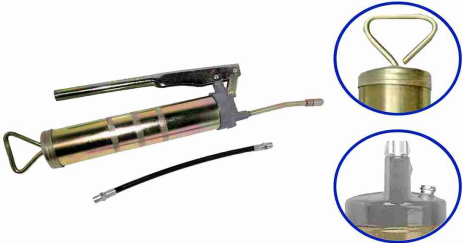

MHT-5413 REF C 16.32
PZA | ENGRASADORA MANUAL 400 CC.
REF A=10.19 REF B=15.5

8L



MHT-5418 REF C 81.6
PZA | ENGRASADORA MANUAL 8LT ALT/
PRES. CROW
REF A=50.94 REF B=77.52

1/8"-3/4"



MHT-5452 REF C 2.78
JGO | EXTRAC.P/TORNILLO ROTOS 5PZ
1/8-3/4
REF A=1.74 REF B=2.64

2" a 8"



MHT-5455 REF C 43.34
PZA | EXTRACTOR 2 MORDAZAS 2" A 8" DIES
0640
REF A=27.05 REF B=41.18



MHT-5457 REF C 22.37
PZA | EXTRACTOR IMPACT. INYECTOR
DIESE. 617
REF A=13.96 REF B=21.25



MHT-5454 REF C 12.28
JGO | EXTRACTOR DE POLEA DIESEL BP01
REF A=7.67 REF B=11.67



3"



CROWNMAN

MHT-5468 REF C 7.89
PZA |EXTRACTOR D/POLEA 3 BRAZO 3"
CROWNA

REF A=4.93 REF B=7.5



4"



CROWNMAN

MHT-5469 REF C 12.07
PZA |EXTRACTOR D/POLEA 3 BRAZO 4"
CROWNMA

REF A=7.53 REF B=11.46



6"



CROWNMAN

MHT-5471 REF C 18.59
PZA |EXTRACTOR D/POLEA 3 BRAZO 6"
CROWNMA

REF A=11.61 REF B=17.67



DIESEL TOOLS

MHT-6110 REF C 6.31
PZA |ESTETOSCOPIO DE CILINDRO P/AUTO
DT

REF A=3.94 REF B=6



8"

DIESEL TOOLS

MHT-6475 REF C 5.3
PZA |ESPATULA P/ENCAMISAR M/GOMA 8"

REF A=3.31 REF B=5.03



10"

DIESEL TOOLS

MHT-6476 REF C 5.78
PZA |ESPATULA P/ENCAMISAR M/GOMA 10"

REF A=3.61 REF B=5.49



12"

DIESEL TOOLS

MHT-6477 REF C 6.26
PZA |ESPATULA P/ENCAMISAR M/GOMA 12"

REF A=3.91 REF B=5.95



11"

KROHN
Steel

MHT-6483 REF C 1.37
PZA |ESPATUL P/
ENCAMISA.PLAST.11"AMARIL

REF A=0.85 REF B=1.3



RIDGID

MHT-6517 REF C 77.01
PZA |FILTRO STANDARD P/ASPIRADORA
RIDGID

REF A=48.07 REF B=73.16



**2 Toneladas
Tipo A**

MHT-7588 REF C 21.43
PZA |GATO BOTELLA DE 2 TONELADAS
TIPO A
REF A=13.38 REF B=20.36



**4 Toneladas
Tipo A**

MHT-7594 REF C 28.24
PZA |GATO BOTELLA DE 4 TONELAD.TIPO A
REF A=17.63 REF B=26.83



8"

DIESEL TOOLS

MHT-7604 REF C 44.06
PZA |GATO BOTELLA DE 8 TONELADAS
DS1685
REF A=27.5 REF B=41.86



10 TON

**FM
FERMETAL**

MHT-7617 REF C 40.61
PZA |GATO BOTELLA DE 10
TONELAD.IMPORT
REF A=25.35 REF B=38.58



12 TON

**FM
FERMETAL**

MHT-7620 REF C 77.12
PZA |GATO BOTELLA DE 12 TONELADA
IMPORT
REF A=48.14 REF B=73.27



20 TON

**FM
FERMETAL**

MHT-7633 REF C 62.6
PZA |GATO BOTELLA DE 20
TONELADA.IMPORT
REF A=39.08 REF B=59.48



30 TON

**FM
FERMETAL**

MHT-7635 REF C 255.18
PZA |GATO BOTELLA DE 30
TONELADA.IMPORT
REF A=159.29 REF B=242.44



50 TON

**FM
FERMETAL**

MHT-7637 REF C 328.02
PZA |GATO BOTELLA DE 50
TONELADA.IMPORT
REF A=204.76 REF B=311.64



1.5TON

DIESEL TOOLS

MHT-7642 REF C 23.68
PZA |GATO MECANICO TIJERA 1.5TON
DT-2105
REF A=14.78 REF B=22.49

2TON



MHT-7645 REF C 31.57
PZA |GATO MECANICO TIJERA 2.0TON
DS-2106
REF A=19.71 REF B=29.99

2 TON



MHT-7648 REF C 52.97
PZA |GATO CAIMAN 2 TON.T/A C/
ESTUCH.DT01
REF A=33.07 REF B=50.33

2TON-12V



MHT-7649 REF C 102.39
PZA |GATO TIJERA 2TON.ELECTRICO 12V
DIES
REF A=63.91 REF B=97.27

2.1/2 TON



MHT-7651 REF C 294.53
PZA |GATO CAIMAN DE 2.1/2 TONELADA
FMT
REF A=183.85 REF B=279.82

3 TON



MHT-7653 REF C 204.74
PZA |GATO CAIMAN DE 3 TON. MAXITOLS
REF A=127.81 REF B=194.52

10 TON



MHT-7655 REF C 367.84
PZA |GATO POWER DE 10 TON FERMETAL
REF A=229.61 REF B=349.47

**500KG
1.90MTS**



MHT-7658 REF C 214.19
PZA |GATO TRANSMISI.HIDRAUL.500K
1.90ALT
REF A=133.7 REF B=203.49

1 TON



MHT-7660 REF C 1073.5
PZA |GATO TRANSMISION HIDRAUL.1TON
MEGA
REF A=670.1 REF B=1019.89

2 TON



MHT-7663 REF C 779.34
PZA |GRUA MOTOR TELESCOPICA 2
TONELADA
REF A=486.48 REF B=740.42



MHT-7947 REF C 326.39
 PZA | HIDROLAVA.3HP 2000PSI 13L/M 110V Q7
REF A=203.74 REF B=310.09



MHT-7960 REF C 1.89
 PZA | INFLADOR PICO AIRE CAUCHO 1/4 DS545
REF A=1.18 REF B=1.8



MHT-7965 REF C 2.62
 PZA | INFLADOR CAUCH.CARRO-CAMION 1/4"04B
REF A=1.64 REF B=2.49



MHT-8368 REF C 3.75
 PZA | LIMPIADOR DE BORNES+CEPILLO DS1234
REF A=2.34 REF B=3.56



MHT-8398 REF C 21.22
 SET | LLAVE DOBLE RATCHET FIJA 5P 6-21M DS
REF A=13.24 REF B=20.16



MHT-8400 REF C 26.83
 SET | LLA.RAT.FIJ.6P 5/16-11/16+8-17M D06
REF A=16.75 REF B=25.49



MHT-8402 REF C 34.65
 SET | LLAVE RATCHET FIJA 7PCS 8-19MM S/M
REF A=21.63 REF B=32.92



MHT-8404 REF C 36.3
 SET | LLAV C/RATCH.FIJ 7PZA 10-19M DS R07
REF A=22.66 REF B=34.49



MHT-8406 REF C 39.38
 SET | LLAV.RATCH.FIJ.8P 5/16-3/4-8-19 D8B
REF A=24.58 REF B=37.41



MHT-8408 REF C 59.85
SET | LLA.RATC.FIJ 12P 5/16-3/4+8-19M
S12
REF A=37.36 REF B=56.86



MHT-8410 REF C 3.91
PZA | LLAVE D/BUJIA.TIP/T.5/8 MAN/AISLAD
REF A=2.44 REF B=3.71



MHT-8411 REF C 3.77
PZA | LLAVE D/BUJIA.TIP/T.13/16"MAN/AISL
REF A=2.35 REF B=3.58



MHT-8428 REF C 4.07
PZA | LLAVE AJUSTABLE CROM.6" C/BLIS.IMP
REF A=2.54 REF B=3.86



MHT-8429 REF C 4.57
PZA | LLAVE AJUSTABLE CROM. 8"C/BLIS.IMP
REF A=2.86 REF B=4.35



MHT-8431 REF C 5.51
PZA | LLAVE AJUSTABLE CROM.10"C/BLIS.IMP
REF A=3.44 REF B=5.24



MHT-8433 REF C 7.38
PZA | LLAVE AJUSTABLE CROM.12"C/BLIS.IMP
REF A=4.61 REF B=7.02



MHT-8435 REF C 14.96
PZA | LLAVE AJUSTABLE CROM.15"C/BLIS.IMP
REF A=9.34 REF B=14.21



MHT-8437 REF C 16.37
JGO | LLAVE COMB CR/VND JG 11P 1/4-3/4
UD
REF A=10.22 REF B=15.56

**11PCS
(6-19 MM)**



UDUKE

MHT-8438 REF C 16.37
JGO | LLAVE COMB CR/VND JGO 11P 6-19M
UDE
REF A=10.22 REF B=15.56

**1/4"
A 13/16"**



UDUKE

MHT-8439 REF C 23.62
JGO | LLAVE COMB CR/VND JG 14Pz
1/4-13/16
REF A=14.75 REF B=22.44

6-21MM



UDUKE

MHT-8440 REF C 23.62
JGO | LLAVE COMB CR/VND JG 14Pz 6-21M
UDE
REF A=14.75 REF B=22.44

**1/4-7/8"
8-18MM**



UDUKE

MHT-8441 REF C 40.32
JGO | LLAV.COMB C/V JG 22P 1/4-7/8-8-18M
REF A=25.17 REF B=38.3

1/4"



UDUKE

MHT-8442 REF C 1.12
PZA | LLAVE COMB.CR/VANAD PROF.1/4"
UDEKE
REF A=0.7 REF B=1.07

5/16"

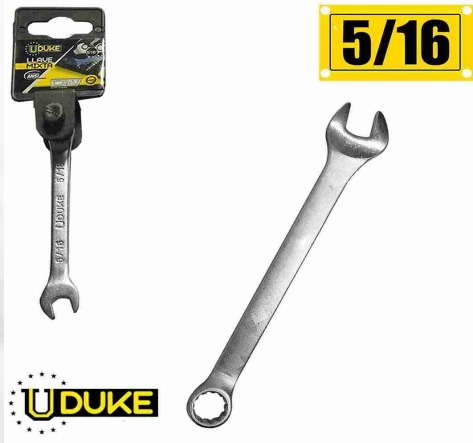

UDUKE

MHT-8444 REF C 1.18
PZA | LLAVE COMB.CR/VANAD PROF.5/16
UDEKE
REF A=0.73 REF B=1.12

3/8"



UDUKE

MHT-8446 REF C 1.26
PZA | LLAVE COMB.CR/VANA T/ACESA
3/8"UDEK
REF A=0.78 REF B=1.19

7/16"



UDUKE

MHT-8447 REF C 1.26
PZA | LLAVE COMB.CR/VANA T/ACES 7/16
UDEK
REF A=0.78 REF B=1.19

1/2"



UDUKE

MHT-8448 REF C 1.77
PZA | LLAVE COMB.CR/VANAD T/ACESA
1/2"UDE
REF A=1.1 REF B=1.68

9/16"



UDUKE

MHT-8450 REF C 1.77
PZA |LLAVE COMB.CR/VANAD T/ACES 9/16
UD
REF A=1.1 REF B=1.68

5/8"



UTUSTOOLS

MHT-8452 REF C 5.63
PZA |LLAVE COMBINAD CR/VANAD T/ACES
5/8
REF A=3.51 REF B=5.35

11/16"



UTUSTOOLS

MHT-8454 REF C 5.72
PZA |LLAVE COMBIN.CR/VANAD PROTUL
11/16
REF A=3.57 REF B=5.44

3/4"



UDUKE

MHT-8456 REF C 2.84
PZA |LLAVE COMB.CR/VANAD T/
ACES.3/4"UDEK
REF A=1.77 REF B=2.69

13/16"



UTUSTOOLS

MHT-8457 REF C 8.93
PZA |LLAVE COMBINA.CR/VANA T/ACES
13/16
REF A=5.57 REF B=8.48

7/8"



UTUSTOOLS

MHT-8458 REF C 9.87
PZA |LLAVE COMBINAD CR/VANA T/ACESA
7/8
REF A=6.16 REF B=9.37

15/16"



UTUSTOOLS

MHT-8459 REF C 13.52
PZA |LLAVE COMBINA.CR/VANA T/ACES
15/16
REF A=8.44 REF B=12.84

1"



UTUSTOOLS

MHT-8460 REF C 15.05
PZA |LLAVE COMBINAD CR/VANA T/ACESA
1"
REF A=9.39 REF B=14.3

1.1/4"



UTUSTOOLS

MHT-8462 REF C 11.52
PZA |LLAVE COMBINA.CR/VANA T/ACES
1.1/4
REF A=7.19 REF B=10.94



1.1/16"

MHT-8464 REF C 20.77
PZA |LLAVE COMBINA.CR/VAN T/ACES
1.1/16
REF A=12.97 REF B=19.73



1.3/16"

MHT-8465 REF C 23.2
PZA |LLAVE COMBIND CR/VAN T/ACES
1.3/16
REF A=14.48 REF B=22.04



23mm

MHT-8473 REF C 5.19
PZA |LLAVE COMB.CR/VANAD T/ACESA
23M UDE
REF A=3.24 REF B=4.93



6mm

MHT-8474 REF C 1.12
PZA |LLAVE COMBINA.CR/VANAD T/ACESA
6MM
REF A=0.7 REF B=1.07



7mm

MHT-8475 REF C 1.26
PZA |LLAVE COMB.CR/VANAD T/ACESA
7MM UDE
REF A=0.78 REF B=1.19



8mm

MHT-8476 REF C 1.18
PZA |LLAVE COMB.CR/VANAD T/ACESA
8MM UDE
REF A=0.73 REF B=1.12



9mm

MHT-8477 REF C 1.2
PZA |LLAVE COMB.CR/VANAD T/ACESA
9MM UDEKE
REF A=0.75 REF B=1.14



11mm

MHT-8479 REF C 1.23
PZA |LLAVE COMB.CR/VANAD T/ACESA
11M UDE
REF A=0.77 REF B=1.17



12mm

MHT-8480 REF C 1.39
PZA |LLAVE COMB.CR/VANAD T/ACESA
12M UDE
REF A=0.87 REF B=1.32

13mm



UDUKE

MHT-8481 REF C 1.52
PZA | LLAVE COMB.CR/VANAD T/ACESA
13M UDE
REF A=0.95 REF B=1.45

14mm



UDUKE

MHT-8482 REF C 1.82
PZA | LLAVE COMB.CR/VANAD T/ACESA
14M UDEK
REF A=1.14 REF B=1.73

15mm



UDUKE

MHT-8483 REF C 1.95
PZA | LLAVE COMB.CR/VANAD T/ACESA
15M UDE
REF A=1.22 REF B=1.86

16mm



UDUKE

MHT-8484 REF C 2.03
PZA | LLAVE COMB.CR/VANAD T/ACESA
16M UDE
REF A=1.27 REF B=1.93

17mm



UDUKE

MHT-8485 REF C 2.27
PZA | LLAVE COMB.CR/VANAD T/ACESA
17M UDE
REF A=1.42 REF B=2.16

18mm



UDUKE

MHT-8486 REF C 2.57
PZA | LLAVE COMB.CR/VANAD T/ACESA
18M UDEK
REF A=1.6 REF B=2.44

19mm



UDUKE

MHT-8487 REF C 2.84
PZA | LLAVE COMB.CR/VANAD T/ACESA
19M UDE
REF A=1.77 REF B=2.69

20mm



UTUSTOOLS

MHT-8488 REF C 7.85
PZA | LLAVE COMBINA.CR/VANAD T/ACESA
20M
REF A=4.9 REF B=7.46

21mm



UTUSTOOLS

MHT-8489 REF C 9.29
PZA | LLAVE COMBINA.CR/VANAD T/ACESA
21M
REF A=5.8 REF B=8.82

22mm



UTUSTOOLS

MHT-8490 REF C 4.39
PZA | LLAVE COMBINA. CR/VANAD T/ACESA
22M
REF A=2.74 REF B=4.17

24mm



MHT-8491 REF C 5.67
PZA | LLAVE COMB. CR/VANAD T/ACESA
24M UDE
REF A=3.54 REF B=5.39

25mm



UTUSTOOLS

MHT-8492 REF C 9.62
PZA | LLAVE COMBINA. CR/VANAD T/ACESA
25M
REF A=6 REF B=9.14

26mm



UTUSTOOLS

MHT-8493 REF C 15.71
PZA | LLAVE COMBINA. CR/VANAD T/ACESA
26M
REF A=9.8 REF B=14.92

28mm



UTUSTOOLS

MHT-8494 REF C 20.51
PZA | LLAVE COMBINA. CR/VANAD T/ACESA
28M
REF A=12.8 REF B=19.49

32mm



UTUSTOOLS

MHT-8495 REF C 27.67
PZA | LLAVE COMBINA. CR/VANAD T/ACESA
32M
REF A=17.27 REF B=26.29



10 PIEZAS TIPO A3

1.5MM - 2MM - 2.5MM - 3MM - 5MM
4MM - 6MM - 8MM - 9MM - 10MM | TAMAÑOS SIZES



ZASC

MHT-8497 REF C 1.61
SET | LLAV. ALLEN HEX. MILIME. 1.5-10M 10P
ZA
REF A=1 REF B=1.53



T10 AL T50



MHT-8508 REF C 6.77
BLT | LLAV TORX T/L JG 9Pz C/H T-10 AL 50
REF A=4.23 REF B=6.43

14"

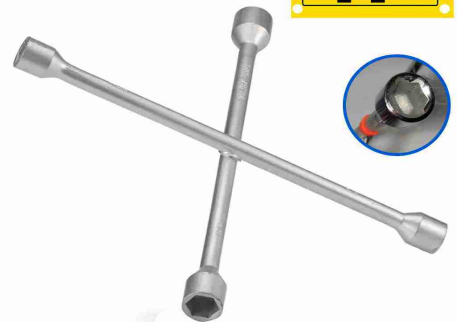

MHT-8562 REF C 13.91
PZA | LLAVE CRUZ CROMADA 14 CW14
REF A=8.68 REF B=13.22



20"



MHT-8563 REF C 28.52
PZA |LLAVE DE CRUZ P/VEHICULOS 20"

REF A=17.8 REF B=27.09



25"



MHT-8565 REF C 119.58
PZA |LLAVE DE CRUZ P/CAMION 25"

REF A=74.65 REF B=113.61



12"

MHT-8569 REF C 4.29
PZA |MANGUERA ENGRASAD.C/PICO 12"310BAR

REF A=2.68 REF B=4.07



12"

MHT-8570 REF C 2.14
PZA |MANGUERA P/ENGRASADORA 12"310BAR IM

REF A=1.34 REF B=2.03



10 a 120L



MHT-8593 REF C 1.42
PZA |MEDID.DE AIRE P/CARRO 10A100PSI Q7

REF A=0.89 REF B=1.35



100lbs



MHT-8594 REF C 3.48
PZA |MEDIDOR PRESION AIRE CARR.100LB 503

REF A=2.17 REF B=3.3



0-100Psi



MHT-8595 REF C 3.85
PZA |MEDIDOR DE AIRE P/CARRO 0A100PS 211

REF A=2.4 REF B=3.66



160LB



MHT-8596 REF C 9.12
PZA |MEDIDOR AIRE CAUCHO CAMION 160LB Q7

REF A=5.69 REF B=8.67



160LBS



MHT-8598 REF C 6.53
PZA |MEDIDOR AIRE CAUCHO CAMION 160LB 03

REF A=4.07 REF B=6.2



**0-25mm
0.01mm**



MHT-8628 REF C 8.61
PZA | MICROMETRO 0-25MM/0.01MM
DIESEL 182

REF A=8.23 REF B=9.08



MHT-8865 REF C 2.12
PZA | PICO PARA ENGRASADORA MANUAL

REF A=1.32 REF B=2.01



100W



MHT-8916 REF C 14.21
PZA | PISTOLA PARA SOLDAR 100W DT-1802

REF A=8.87 REF B=13.5



100W



MHT-8918 REF C 31.84
PZA | PISTOLA PARA SOLDAR BESTVALUE
100W

REF A=19.87 REF B=30.25



**7" -1100w
30000 Rpm**



MHT-8936 REF C 78.33
PZA | PULIDORA CAR.7" 1100W 3000RPM
DS180

REF A=48.9 REF B=74.42



7 PCS



MHT-8995 REF C 53.67
JGO | KIT P/LATONERO DE 7 PZAS.DS-RH007

REF A=33.5 REF B=50.99



150 PIEZAS



MHT-9000 REF C 3.72
KIT | KIT DE CUPILLAS 150PZA SURTIDAS

REF A=2.32 REF B=3.53



300Pcs



MHT-9001 REF C 8.03
KIT | KIT DE RETENES 300PZA SURT.DT-
KD300

REF A=5.01 REF B=7.63



200PCS



MHT-9002 REF C 6.67
KIT | KIT DE RESORTE 200PZ SURTIDAS
DS200

REF A=4.16 REF B=6.34

200PCS



MHT-9003 REF C 5.73
KIT | KIT RESORTE SURTIDO 200PCS SEA M5

REF A=3.57 REF B=5.44



222 PIEZAS



MHT-9004 REF C 7.84
KIT | KIT DE ORING 222 PZA SURTIDAS DIESE

REF A=4.89 REF B=7.45



280PCS



MHT-9005 REF C 19.58
KIT | KIT ARANDELA COBRE 280 PZA DT-280

REF A=12.22 REF B=18.61

110 PCS



MHT-9006 REF C 16.43
KIT | KIT D/GRASERA 110 PIEZAS/SURTIDA DT

REF A=10.25 REF B=15.61



8PCS



MHT-9010 REF C 8.46
JGO | KIT TERMINAL DE BATERIA 8PZ DS-J001

REF A=5.28 REF B=8.04



127Pcs



MHT-9017 REF C 3.16
KIT | KIT TERMOENCOGIBLE SURT. Q7-HS127PZA

REF A=1.97 REF B=3

127Pcs



MHT-9018 REF C 3.16
KIT | KIT TERMOENCOGIBLE SURTIDOS 127 PZA

REF A=1.97 REF B=3



1/2-3/4-1"



MHT-9212 REF C 7.33
JGO | TARRAJA MANU.PLAS.1/2-3/4-1"MAP/WQ

REF A=4.58 REF B=6.96



MHT-9215 REF C 156.67
PZA | TARRAJA PROF.MAN.1/2-3/4-1-1.1/2-2"

REF A=97.8 REF B=148.84



**1/2-3/4
-1"**

MHT-9216 REF C 10.2
PZA | TARRJ.MAN.P/T PVC1/2-3/4-1 "M/
NUEVO
REF A=6.37 REF B=9.69



1/2"

MHT-9368 REF C 48.32
PZA | TORQUIMETRO DE 1/2" 150 LB-FT Q7
REF A=30.16 REF B=45.9



3pcs

MRA-0058 REF C 13.7
SET | ALFOMBRA P/CARRO GOMA 3 PCS
DIESEL
REF A=8.55 REF B=13.01



MRA-0065 REF C 13.43
SET | ALFOMBRA P/CARRO GOMA 4 PCS
CM-4P
REF A=8.38 REF B=12.76



MRA-0100 REF C 22.85
KIT | AMOLADOR CILINDRO 3GARRAS P/
MOTOR DI
REF A=14.26 REF B=21.71



**2M
1000A**

MRA-0900 REF C 8.35
PZA | CABLE AUXILIAR BATERIA 2MTS
1000AMP
REF A=5.21 REF B=7.93



**350 A
6 AWG**

MRA-0910 REF C 16
SET | CABL.AUXIL.BATERIA 3.65M 6AWG
350A VT
REF A=9.99 REF B=15.2



C/18-16

MRA-1010 REF C 6.53
PQT | CAPUCHON NARANJA C/18-16 P/
CABLE
REF A=4.08 REF B=6.21



C/14-10

MRA-1020 REF C 10.89
PQT | CAPUCHON AMARILLO C/14-10 P/
CABLE
REF A=6.8 REF B=10.34



270mm



MRA-1300 REF C 21.67
PAR | COMPRESOR RESORTE P/ESPIRAL
270MM DS

REF A=13.53 REF B=20.59



**12V
150PSI-85L**

HEAVY DUTY AIR COMPRESSOR
Voltage DC 12V-13.5V
Max. Amperage 23 Amp
Max. pressure 150 PSI
Flow Rate 85L/Min.
CAUTION: The Unit May Get Hot When
Operated For Long Periods Of Time.
READ INSTRUCTIONS

MRA-1350 REF C 91.34
PZA | COMPRES.AIR.12V 150PSI 85L/MIN
YUNG

REF A=57.01 REF B=86.78



MRA-2250 REF C 16.32
KIT | EXTRACTOR D/RESORTE DE VALVULA
DIES

REF A=10.19 REF B=15.5



15Amp

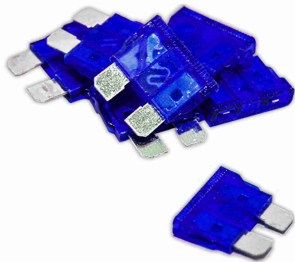

MRA-2805 REF C 9.68
CJA | FUSIBLE T/MUEL.AT15AMP AZUL
C/100p

REF A=6.04 REF B=9.19

20Amp

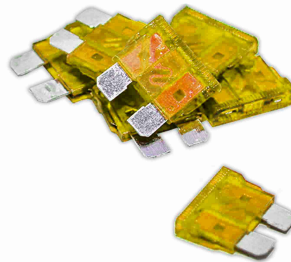

MRA-2810 REF C 9.68
CJA | FUSIBLE T/MUEL.AT 20AMP AMAR
C/100p

REF A=6.04 REF B=9.19

25Amp



MRA-2815 REF C 9.68
CJA | FUSIBLE T/MUEL.AT25AMP TRAS
C/100p

REF A=6.04 REF B=9.19

30Amp



MRA-2820 REF C 9.68
CJA | FUSIBLE T/MUEL.AT30AMP VERD
C/100p

REF A=6.04 REF B=9.19



MRA-2860 REF C 18.78
SET | FLEJADORA+ALICATE TRIPOIDE AUTO
P02

REF A=11.72 REF B=17.84



MRA-4200 REF C 75.61
JGO | KIT SEPARADOR REMOVEDOR MUNON
J010

REF A=47.19 REF B=71.83



DIESEL TOOLS

MRA-4210 REF C 51.98
JGO |KIT HERRAM.SINCROZACION
MOTOR 302

REF A=32.45 REF B=49.38



DIESEL TOOLS

MRA-4212 REF C 58.75
KIT | KIT SINCROZAC.TIEMP.FORD-MAZD
T16

REF A=36.67 REF B=55.82



DIESEL TOOLS

MRA-4215 REF C 28.99
JGO |KIT HERRAM.AJUST.TIEMPO
AUTOMOTR.16

REF A=18.09 REF B=27.54



DIESEL TOOLS

MRA-4220 REF C 85.05
JGO |KIT EXTRACTOR MARTILLO D/REBOTE
016

REF A=53.09 REF B=80.8



3/8"

DIESEL TOOLS

MRA-4223 REF C 63.65
JGO |KIT COPA CAMB.FILT.ACEI.RAC.3/8
001

REF A=39.73 REF B=60.47



3/8"

DIESEL TOOLS

MRA-4225 REF C 45.78
JGO |KIT COPA CAMB.FILT.ACEI.RAC.3/8
007

REF A=28.57 REF B=43.49



DIESEL TOOLS

16PC ALUMINUM LIL FILTER CAP WRENCH SOCKET REMOVAL TOOL SET

TYPE	SIZE	TOYOTA	SITE/USE DESCRIPTION
M6	27	14	TOYOTA, NISSAN, FIAT, ELANTRA
M6	27	14	DAHATSU, TOYOTA
M6x1	27	15	AUDI, ROVER, CHRYSLER
M6x1	27	14	TOYOTA, LEXUS
M6	27	15	NISSAN, FORD
M6x1	27	14	BMW, MERCEDES, VOLVO, AUDI, VW
M6	24	12	DAEWOO/DAEWU, SKODA/SEAT
M6	27	15	MINI, SUBARU, TOYOTA
M6	27	15	SEAT, NISSAN
M6	27	15	TOYOTA, ALFA ROMEO, FORD
M6	27	15	FIAT, FERRARI, CITROEN
M6x1	27	15	TOYOTA, HONDA, NISSAN, CHRYSLER
M6	27	15	MAZDA, TOYOTA
M6	27	15	FRECCIA, JMC

MRA-4227 REF C 51.98
JGO |KIT COPA/CAMB.FIL.ACEI.15P C/LL
015

REF A=32.45 REF B=49.39



DIESEL TOOLS

MRA-4231 REF C 48.96
JGO |KIT EXTRACT.RODAMIENTO INTERNO
992

REF A=30.56 REF B=46.51



DIESEL TOOLS

MRA-4232 REF C 31.01
JGO |KIT EXTRAC.POLEA BOMBA
DIRECCIO.795

REF A=19.36 REF B=29.46



DIESEL TOOLS

MRA-4237 REF C 37.72
JGO |KIT MEDIDOR COMPRESION CILINDRO U21

REF A=23.55 REF B=35.84



DIESEL TOOLS

MRA-4242 REF C 146.88
JGO |KIT EXTRA/MONTA BUJE MESET-RUEDA023

REF A=91.68 REF B=139.54



DIESEL TOOLS

MRA-4245 REF C 23.6
JGO |K.PROBAD.COMPRESION MOTOR GASOL.016

REF A=14.73 REF B=22.42



DIESEL TOOLS

MRA-4247 REF C 39.46
JGO |KIT PROB.PRESION BOMB.ACEIT.MOTOR06

REF A=24.63 REF B=37.49



DIESEL TOOLS

MRA-4248 REF C 114.24
JGO |KIT MEDID.PRES.INYECCI.BOMB.GASOL43

REF A=71.31 REF B=108.53



DIESEL TOOLS

MRA-4249 REF C 37.54
JGO |K.PROB.COMPRESION MOTOR GASOL.B7007

REF A=23.43 REF B=35.66



DIESEL TOOLS

MRA-4252 REF C 81.6
JGO |KIT DE CAMBIO DE GOMA VALVULA 15303

REF A=50.94 REF B=77.52



DIESEL TOOLS

MRA-4257 REF C 77.18
JGO |KIT EXTRACTOR D/GUIA D/VALVULAS 061

REF A=48.18 REF B=73.33



DIESEL TOOLS

MRA-4260 REF C 78.76
KIT | K.EXTRA.INT/EXT.C/MART.DEZLIZ.3G 05

REF A=49.16 REF B=74.83



DIESEL TOOLS

MRA-4270 REF C 51.98
SET | KIT 7pz PICO ASCESOR.P/
PIST.ENGRASE
REF A=32.45 REF B=49.39



DIESEL TOOLS

MRA-4275 REF C 45.67
KIT | KIT COMPRES.UNIV.D/
RESORT.VALVU4025
REF A=28.51 REF B=43.39



DIESEL TOOLS

MRA-4280 REF C 44.06
KIT | KIT PULIDOR CILINDR.FRENO+MOTOR
86Z
REF A=27.5 REF B=41.86



DIESEL TOOLS

MRA-4283 REF C 37.35
KIT | KIT PULGADOR FRENO-VACIO C/
BOMBA 22
REF A=23.32 REF B=35.49



DIESEL TOOLS

MRA-4290 REF C 62.6
KIT | K.INSTALAC.ANILLO-PISTON MOTOR
P011
REF A=39.08 REF B=59.48



DIESEL TOOLS

MRA-4295 REF C 25.2
KIT | K.INSTALAC.EXTRAC.SELLOS
VALVUL.011
REF A=15.73 REF B=23.94



DIESEL TOOLS

MRA-4300 REF C 75.61
KIT | K.INSTAL.REMOVED.SELLO MANIVELA
R24
REF A=47.19 REF B=71.83



DIESEL TOOLS

MRA-4980 REF C 11.91
PZA | LLAV.RUED.TELESCOP.1/2"X17-19-21-
23M
REF A=7.43 REF B=11.31



DIESEL TOOLS

MRA-5000 REF C 10.27
PZA | LLAV.SACAR FILT.ACEITE
3GAR.65-130M
REF A=6.41 REF B=9.76



MRA-5450 REF C 83.47
 PZA | MEDIDOR PRESION D/CILINDRO P/
 CAMION
 REF A=52.1 REF B=79.3



MRA-5460 REF C 28.89
 KIT | KIT MEDID.PRES-
 BOMB.GASL.INYEC.D113
 REF A=18.04 REF B=27.45



MRA-5470 REF C 84.86
 KIT | K:PUNTA+DADO.COMB.POLEA
 ALTERNAD.024
 REF A=52.97 REF B=80.62



MRA-5520 REF C 26.06
 PZA | MORDAZA PARA LATONERIA DS-
 SM125
 REF A=16.27 REF B=24.76



MRA-5842 REF C 4.52
 BLT | PINZA METALICA DE RESORTE 4'2pza
 REF A=2.82 REF B=4.3



MRA-5844 REF C 7.98
 BLT | PINZA METALICA DE RESORTE 6'2pza
 REF A=4.98 REF B=7.58



MRA-5850 REF C 1.26
 PAR | PINZA P/CABLE 30 AMP ROJO/NEGRA
 PAR
 REF A=0.78 REF B=1.19



MRA-5950 REF C 6.99
 PZA | PUENTE PARA BATERIA GRANDE
 REF A=4.37 REF B=6.64



MRA-6000 REF C 3
 PZA | PROBADOR DE 6 Y 12 VOLTIOS IMP
 REF A=1.87 REF B=2.85



6-12-24V



MRA-6001 REF C 7.36
PZA |PROBAD.6-12-24V HD.CABL/
ESPIR.JT001
REF A=4.59 REF B=6.99



**TESTER PARA
CIRCUITO CERRADO
O ABIERTO**



MRA-6005 REF C 2.68
PZA |PROBAD.DE CONTINUIDAD D/
BATERIA.851
REF A=1.67 REF B=2.54



6 y 12V



MRA-6010 REF C 31.49
PZA |PROBADOR D/CARGA BATERIA 6 Y
12V DIE
REF A=19.66 REF B=29.92



60cm



MRA-6200 REF C 1.58
PZA |RECOJEDOR MAGNETIC.FLEXIBL.60CM
025
REF A=0.99 REF B=1.5



2"

MRA-6700 REF C 1.68
PZA |TAPA TAMBOR METALICO 2"
REF A=1.05 REF B=1.6



**1/8" AWG
20-16**

MRA-7004 REF C 7.26
PQT |TERM.ANILL.S/AIS.1/8 AWG 20-16
LAT.
REF A=4.53 REF B=6.89



**5/32" AWG
22-18**

MRA-7005 REF C 9.68
PQT |TERM.ANILL.S/AIS.5/32AWG 22-18
LAT
REF A=6.04 REF B=9.19



**3/16" AWG
18-14**

MRA-7006 REF C 12.1
PQT |TERM.ANILL.S/AIS.3/16 AWG 18-14
LAT
REF A=7.55 REF B=11.49



**1/4" AWG
18-14**

MRA-7012 REF C 21.77
PQT |TERM.ANILL.S/AIS.1/4 AWG 18-14 LAT
REF A=13.59 REF B=20.68

**5/16" AWG
18-14**



MRA-7016 REF C 24.19
PQT |TER.ANIL.S/AIS.5/16 AWG 18-14 L/EST
REF A=15.1 REF B=22.98

**3/8" AWG
18-14**



MRA-7018 REF C 13.98
PQT |TER.ANIL.S/AIS.3/8 AWG 18-14
LATON
REF A=8.73 REF B=13.28

**187 AWG
22-18**



MRA-7040 REF C 4.6
PQT |TER.HEM/REC.S/AIS.187AW22-18L/ES
100P
REF A=2.87 REF B=4.37

**205 AWG
22-18**



MRA-7042 REF C 7.21
PQT |TER.HEM/REC.S/AIS.205AW 22-18LAT
100P
REF A=4.5 REF B=6.85

**205 AWG
22-18**

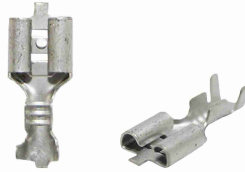

MRA-7044 REF C 6.65
PQT |TER.HEM/REC.S/AIS.205AW 22-18L/ES
100P
REF A=4.15 REF B=6.32

**HEMBRA
22/18**



MRA-7806 REF C 9.92
PQT |TERMIN.ROJO 22/18 HEMBR AIS
PV1257A
REF A=6.19 REF B=9.42

**HEMBRA
22/18**



MRA-7812 REF C 10.28
PQT |TERMIN.ROJO 22/18 HEM.PL/M5
V1255A
REF A=6.42 REF B=9.77

**MACHO
22/18 - M7**



MRA-7818 REF C 5.56
PQT |TERMIN.ROJO 22/18 MAC.PL/M7
V1257B
REF A=3.47 REF B=5.29

**1/8"-M3
22/18**



MRA-7820 REF C 3.14
PQT |TERM.ROJ 22/18 ANILL.M3 1/8
ARA125
REF A=1.96 REF B=2.99

**5/32"-M4
22/18**



MRA-7821 REF C 3.14
PQT |TERM.ROJ 22/18 ANIL.M4 5/32
RF1254
REF A=1.96 REF B=2.99

**3/16"-M5
22/18**



MRA-7824 REF C 3.63
PQT |TERM.ROJ 22/18 ANILL.M5 3/16
RF1255
REF A=2.27 REF B=3.45

**1/4"-M6
22/18**



MRA-7827 REF C 5.56
PQT |TERM.ROJ 22/18 ANILLO.M6 1/4
RF1256
REF A=3.47 REF B=5.29

**1/8"-M3
22/18**



MRA-7830 REF C 3.14
PQT |TERM.ROJ 22/18 HORQ.M3 1/8
YF1253
REF A=1.96 REF B=2.99

**5/32"-M4
22/18**



MRA-7833 REF C 3.14
PQT |TERM.ROJ 22/18 HORQ.M4 5/32 YF
1254
REF A=1.96 REF B=2.99

**3/16"-M5
22/18**



MRA-7836 REF C 3.63
PQT |TERM.ROJ 22/18 HORQ.M5 3/16 YF
1255
REF A=2.27 REF B=3.45

**HEMBRA
16/14**



MRA-7845 REF C 9.92
PQT |TERM.AZUL 16/14 HEMB/
AISLADO.PV27-A
REF A=6.19 REF B=9.42

**HEMBRA-M5
16/14-V25-A**



MRA-7851 REF C 8.22
PQT |TERM.AZUL 16/14 HEMB/PLAN.M5
V25-A
REF A=5.13 REF B=7.81

**HEMBRA-M7
16/14-V27-A**



MRA-7854 REF C 7.43
PQT |TERM.AZUL 16/14 HEMB/PLAN.M7
V27-A
REF A=4.64 REF B=7.06

**MACHO-M7
16/14 V27-B**

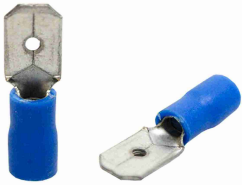

MRA-7857 REF C 6.05
PQT |TERM.AZUL 16/14 MACHO PLANO
V27-B
REF A=3.78 REF B=5.75

**5/32"-M4
16/14 RF24**



MRA-7860 REF C 3.63
PQT |TERM.AZUL 16/14 ANILLO.M4 5/32
RF24
REF A=2.27 REF B=3.45

**3/16"-M5
16/14 RF25**



MRA-7863 REF C 4.6
PQT |TERM.AZUL 16/14 ANILLO.M5 3/16
RF25
REF A=2.87 REF B=4.37

**1/4"-M6
16/14 RF26**



MRA-7866 REF C 5.81
PQT |TERM.AZUL 16/14 ANILLO.M6 1/4
RF26
REF A=3.62 REF B=5.52

**5/16"-M8
16/14 RF28**



MRA-7869 REF C 5.81
PQT |TERM.AZUL 16/14 ANILLO.M8 5/16
RF28
REF A=3.62 REF B=5.52

**1/8"-M3
16/14 YF23S**



MRA-7872 REF C 3.63
PQT |TERM.AZUL 16/14 HORQ.M3 1/8
YF23S
REF A=2.27 REF B=3.45

**5/32"-M4
16/14 YF24**



MRA-7875 REF C 3.63
PQT |TERM.AZUL 16/14 HORQ.M4 5/32
YF24
REF A=2.27 REF B=3.45

**3/16"-M5
16/14 YF25**

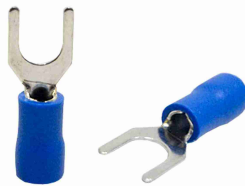

MRA-7878 REF C 4.35
PQT |TERM.AZUL 16/14 HORQ.M5 3/16
YF25
REF A=2.72 REF B=4.14

**1/4"-M6
16/14 YF26**

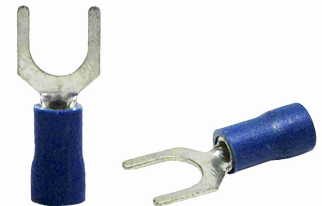

MRA-7881 REF C 5.81
PQT |TERM.AZUL 16/14 HORQ.M6 1/4
YF26
REF A=3.62 REF B=5.52

**HEMBRA
16/14 PV557A**



MRA-7890 REF C 19.35

PQT |TERM.AMAR 16/14 HEMB/
AISLAD.PV557-A

REF A=12.08 REF B=18.39

**HEMBRA
12/10 V557A**



MRA-7891 REF C 21.77

PQT |TERM.AMAR 12/10 HEMB/REC 375
V557-A

REF A=13.59 REF B=20.68

**HEMBRA 250
12/10 V557A**



MRA-7892 REF C 9.87

PQT |TERM.AMAR 12/10 HEMB/PL 250
V557-A

REF A=6.16 REF B=9.38

**HEMB/MACHO
12/10 280**



MRA-7893 REF C 20.08

PQT |TERM.AMAR 12/10 HEMB/MACHO
280

REF A=12.53 REF B=19.08

**HEMB/REDON
12/10 M7-280**

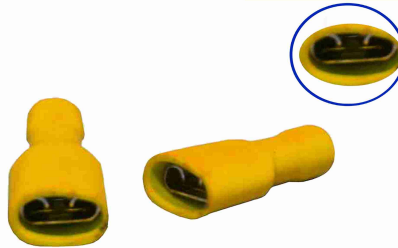

MRA-7894 REF C 21.29

PQT |TERM.AMAR 12/10 HEMB/REDON M7
195

REF A=13.29 REF B=20.22

**MACHO REDO.
12/10 195**



MRA-7896 REF C 21.29

PQT |TERM.AMAR 12/10 MACHO/REDO 195

REF A=13.29 REF B=20.22

**5/32" - M5
12/10 AA156**



MRA-7897 REF C 9.19

PQT |TERM.AMAR 12/10 ANIL.M5 5/32
AA156

REF A=5.74 REF B=8.73

**1/4" - M6
12/10 RF556**



MRA-7901 REF C 10.89

PQT |TERM.AMAR 12/10 ANIL.M6 1/4
RF556

REF A=6.8 REF B=10.34

**5/16" - M8
12/10 RF558**



MRA-7904 REF C 17.42

PQT |TERM.AMAR 12/10 ANIL.M8 5/16
RF558

REF A=10.87 REF B=16.55

3/8" - M10
12/10 RF5510



MRA-7907 REF C 17.66
PQT |TERM.AMAR 12/10 ANIL.M10 3/8
RF5510
REF A=11.02 REF B=16.78

1/2" - M10
12/10 AAA500



MRA-7908 REF C 28.54
PQT |TERM.AMAR 12/10 ANIL.M10 1/2
AAA500
REF A=17.82 REF B=27.12

12/10"
HORQ. M5 3/16"



MRA-7913 REF C 9.68
PQT |TERM.AMAR 12/10 HORQ.M5 3/16
YF555
REF A=6.04 REF B=9.19

12/10"
HORQ. M6 1/4"



MRA-7916 REF C 9.68
PQT |TERM.AMAR 12/10 HORQ.M6 1/4
YF556
REF A=6.04 REF B=9.19

12/10"
HORQ. M5 5/16"



MRA-7919 REF C 29.03
PQT |TERM.AMAR 12/10 HORQ.M5 5/16
AAO312
REF A=18.12 REF B=27.58

3/16AWG



MRA-8000 REF C 0.17
PZA |TERM.ANIL.COBRE 3/16AWG 12-10
AUT
REF A=0.11 REF B=0.16

1/4"
AWG 8-6



MRA-8005 REF C 0.31
PZA |TERM.ANIL.COBRE 1/4AWG 8-6 AUT
REF A=0.2 REF B=0.3

3/8"
AWG 8-10



MRA-8015 REF C 0.31
PZA |TERM.ANIL.COBRE 3/8AWG 8-10 AUT
REF A=0.2 REF B=0.3

3/8 AWG
200A



MRA-8026 REF C 0.35
PZA |TER.ANIL.COBR.ABIER.3/8AWG 4-2
AUTO
REF A=0.22 REF B=0.33



MRA-9007 REF C 11.24
 KIT | KIT FUSIBLE TIPO MUELA
 SURTID.181PZ
 REF A=7.01 REF B=10.68



MRA-9012 REF C 12.04
 KIT | KIT REMACHES PLASTICO PRESION
 240PZ
 REF A=7.52 REF B=11.44



MRA-9017 REF C 14.18
 KIT | KIT REMACHES
 PLAS.PRES.AUTOMOT.620P
 REF A=8.85 REF B=13.47



MRA-9900 REF C 11.54
 PZA | ZUNCHO PEQUENO DE 2.3/4 A 2.1/4
 REF A=7.2 REF B=10.96



MRD-2260 REF C 13.38
 PZA | EXTRACTOR T/GUILLOTIN.D/
 ROLIN.2"050
 REF A=8.35 REF B=12.71



MRD-2262 REF C 23.68
 PZA | EXTRACTOR T/GUILLOTIN.D/
 ROLIN.3"075
 REF A=14.78 REF B=22.49



MRD-2264 REF C 43.34
 PZA | EXTRACTOR T/GUILLOTIN.D/
 ROLIN.4"105
 REF A=27.05 REF B=41.18



MRD-2280 REF C 3.16
 JGO | EXTENSION MECAN.P/RACH.1/4" 3PC
 471
 REF A=1.97 REF B=3



MRD-2284 REF C 3.75
 JGO | EXTENS.MEC.P/RACH.1/4"3P
 3-4-6"3015
 REF A=2.34 REF B=3.56



MRD-2315 REF C 5.54
 JGO | EXTENSION MECAN.P/RACH.3/8" 3PC
 461
 REF A=3.46 REF B=5.26



MRD-2317 REF C 5.19
 JGO | EXTENSION MECAN.P/RACH.3/8" 3PC
 6-3/8
 REF A=3.24 REF B=4.93



MRD-2320 REF C 6.13
 JGO | EXTENS.MEC.P/RAC.3/8 BARR+2EXT
 2-38
 REF A=3.82 REF B=5.82



MRD-2360 REF C 7.17
 JGO | EXTENSIO MECAN.P/RACHT 1/2" 3PC
 451
 REF A=4.48 REF B=6.81



MRD-2450 REF C 1.42
 PZA | DADOS HEX.LARGO CROM.3/8 X 8 MM
 REF A=0.89 REF B=1.35



MRD-2453 REF C 1.42
 PZA | DADOS HEX.LARGO CROM.3/8 X
 10MM
 REF A=0.89 REF B=1.35



MRD-2456 REF C 1.74
 PZA | DADOS HEX.LARGO CROM.3/8 X
 11MM
 REF A=1.09 REF B=1.65



MRD-2459 REF C 1.74
 PZA | DADOS HEX.LARGO CROM.3/8 X
 12MM
 REF A=1.09 REF B=1.65



MRD-2462 REF C 1.74
 PZA | DADOS HEX.LARGO CROM.3/8 X
 13MM
 REF A=1.09 REF B=1.65



14mm



MRD-2465 REF C 1.74
PZA | DADOS HEX.LARGO CROM.3/8 X 14MM
REF A=1.09 REF B=1.65



3/8x15"



MRD-2468 REF C 2.03
PZA | DADOS HEX.LARGO CROM.3/8 X 15MM
REF A=1.27 REF B=1.93



3/8" 8-21MM



MRD-2483 REF C 20.47
JGO | DADOS LARGO 3/8 10P 8-21M SRUN-9021
REF A=12.78 REF B=19.44



3/8"



MRD-2490 REF C 5.35
JGO | DADOS CORTO 3/8 9P 10-19M D10730
REF A=3.34 REF B=5.08



1/2" x10mm

MRD-2512 REF C 1.77
PZA | DADOS HEX.LARGO CROM.1/2 X 10M
REF A=1.1 REF B=1.68



1/2" x11mm

MRD-2515 REF C 2.51
PZA | DADOS HEX.LARGO.CROM.1/2 X 11M
REF A=1.57 REF B=2.39



1/2" x12mm

MRD-2518 REF C 1.77
PZA | DADOS HEX.LARGO.CROM.1/2 X 12M
REF A=1.1 REF B=1.68



1/2" x13mm

MRD-2521 REF C 1.9
PZA | DADOS HEX.LARGO CROM.1/2 X 13M
REF A=1.19 REF B=1.8



1/2" x15mm

MRD-2527 REF C 1.74
PZA | DADOS HEX.LARGO.CROM 1/2 X 15M
REF A=1.09 REF B=1.65



1/2" x16mm



MRD-2528 REF C 1.74
PZA |DADOS HEX.LARGO.CROM.1/2 X 16M

REF A=1.09 REF B=1.65



1/2" x17mm



MRD-2530 REF C 2.03
PZA |DADOS HEX.LARGO.CROM.1/2 X 17M

REF A=1.27 REF B=1.93



1/2" x18mm



MRD-2533 REF C 2.51
PZA |DADOS HEX.LARGO.CROM.1/2 X 18M

REF A=1.57 REF B=2.39



1/2" x8m



MRD-2670 REF C 1.62
PZA |DADOS 6P.MEC.CRO/VAN.1/2 X 8M UYUS

REF A=1.01 REF B=1.54



1/2" x9m



MRD-2673 REF C 1.7
PZA |DADOS 6P.MEC.CRO/VAN.1/2 X 9M UYUS

REF A=1.06 REF B=1.61



1/2" x10m



MRD-2677 REF C 1.7
PZA |DADOS 6P.MEC.CRO/VAN.1/2 X 10M UYUS

REF A=1.06 REF B=1.61



1/2" x11m



MRD-2700 REF C 1.6
PZA |DADOS 6P.MEC.CRO/VAN.1/2X11M VI/UYU

REF A=1 REF B=1.52



1/2" x12m



MRD-2703 REF C 1.62
PZA |DADOS 6P.MEC.CRO/VAN.1/2 X 12M UYUS

REF A=1.01 REF B=1.54



1/2" x13m



MRD-2707 REF C 1.74
PZA |DADOS 6P.MEC.CRO/VAN.1/2X13M VI/UYU

REF A=1.09 REF B=1.66

1/2"x15m



UUSTOOLS

MRD-2713 REF C 1.72
PZA | DADOS 6P.MEC.CRO/VAN.1/2 X 15M UYUS
REF A=1.07 REF B=1.63

1/2"x16m



UUSTOOLS

MRD-2717 REF C 1.62
PZA | DADOS 6P.MEC.CRO/VAN.1/2 X 16M UYUS
REF A=1.01 REF B=1.54

1/2"x17m



UUSTOOLS

MRD-2720 REF C 1.93
PZA | DADOS 6P.MEC.CRO/VAN.1/2 X 17M UYUS
REF A=1.21 REF B=1.83

1/2"x18m



UUSTOOLS

MRD-2723 REF C 2.1
PZA | DADOS 6P.MEC.CRO/VAN.1/2 X 18M UYUS
REF A=1.31 REF B=1.99

1/2"x19m



UUSTOOLS

MRD-2727 REF C 2.17
PZA | DADOS 6P.MEC.CRO/VAN.1/2 X 19M UYUS
REF A=1.35 REF B=2.06

1/2" x21mm



UUSTOOLS

MRD-2733 REF C 2.38
PZA | DADOS 6P.MEC.CRO/VAN.1/2 X 21M VINK
REF A=1.48 REF B=2.26

1/2" x27mm



UUSTOOLS

MRD-2745 REF C 4.59
PZA | DADOS 6P.MEC.CRO/VAN.1/2X27M VINK
REF A=2.87 REF B=4.36

1/2" 8-21MM



SRUNV
AUTO TOOLS

MRD-2778 REF C 22.69
JGO | DADOS 6PT.9PCS LARGO 8-21M X1/2 020
REF A=14.16 REF B=21.55

1/2"



DIESEL TOOLS

MRD-2781 REF C 20.47
JGO | DADOS 6PT.10PCS LARG.13-24M X1/2 71
REF A=12.78 REF B=19.44



**E10 A E24
X1/2"**



MRD-2787 REF C 11.26
**JGO | DADOS TORK JG.9P E10 A E24 X1/2
 177**
REF A=7.03 REF B=10.7



**E8 A E24
X1/2"**



MRD-2790 REF C 10.78
**JGO | DADOS TORX.JG.14P E8 A E24 X1/2
 176**
REF A=6.73 REF B=10.24



1/2"



MRD-2800 REF C 19.42
**JGO | DADO TORX 1/2"10P COR/
 LAR.M5-110-12**
REF A=12.12 REF B=18.45



30pcs



MRD-2810 REF C 24
**JGO | DADOS Y MACHOS TORX JGO 1/4-3/8
 001**
REF A=14.98 REF B=22.8



1/4"



MRD-3500 REF C 13.89
**BLT | DADO COMB.JUEGO 7p
 RAT-1/4"HM-1762**
REF A=8.67 REF B=13.2



1/4x3/8"



MRD-3510 REF C 9.79
**JGO | DADOS SOCKET 1/4 & 3/8 40p C/P
 DIES**
REF A=6.11 REF B=9.3



1/4"-3/8"



MRD-3512 REF C 8.83
**JGO | DADOS SOCKET 1/4&3/8 40p C/
 PL.DOBER**
REF A=5.51 REF B=8.39



3/8"



MRD-3525 REF C 18.5
**JGO | DADOS COMB+RATCH.3/8JG 12P
 10-24M D**
REF A=11.55 REF B=17.58



**1/2"
8-24mm**



MRD-3528 REF C 13.22
**JGO | DADOS 1/2"JGO 10P
 8-24MM+PALAN.9"02**
REF A=8.25 REF B=12.56



1/2"
10-24mm



MRD-3530 REF C 27.42
JGO | DADOS 1/2" JGO 12P 10-24MM+RACH Q743
REF A=17.12 REF B=26.05



1/2"
8-27mm

MRD-3550 REF C 20.59
JGO | DADOS 1/2" 13P 8-27M RACH+PAL.TR013
REF A=12.85 REF B=19.56



1/2"
8-32mm



MRD-3560 REF C 48.56
JGO | DADOS 1/2" 25P 8-32MM+RACH MXH0901
REF A=30.31 REF B=46.13

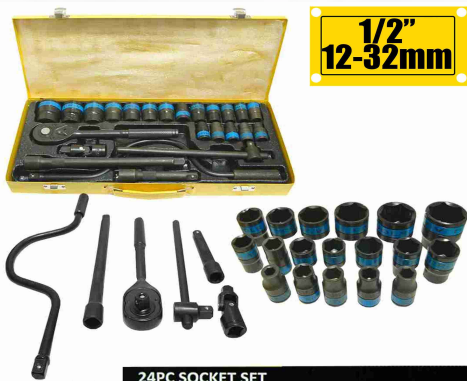

1/2"
12-32mm



MRD-3572 REF C 50.03
JGO | DADO.1/2" IMPACTO 12-32 24P+RAC.LH24
REF A=31.23 REF B=47.53

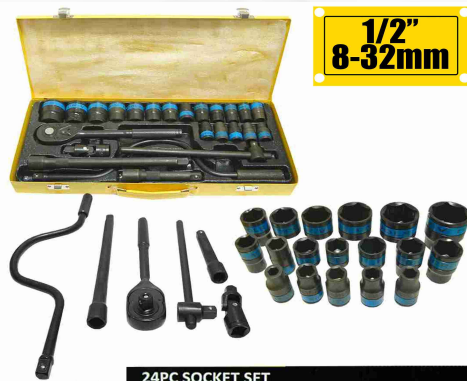

1/2"
8-32mm



MRD-3575 REF C 51.48
JGO | DADOS 1/2" 24P 8-32MM+RACHE MXG107B
REF A=32.14 REF B=48.91



1/2"
8-32mm



MRD-3578 REF C 45.61
JGO | DADOS 1/2" 24P 8-32MM+RACHE MXG107
REF A=28.47 REF B=43.33



MRD-3581 REF C 44.13
JGO | DADOS 1/2" 25P 8-32M+RACHE MXH0901B
REF A=27.55 REF B=41.93



1/2"
8-24mm

MRD-3660 REF C 34.65
JGO | DADO LARG.1/2" 10P.NEUMAT.8-24m 1746
REF A=21.63 REF B=32.92



1/2"
13pcs

MRD-3669 REF C 55.11
JGO | DAD.LAR.1/2" 13P.NEUMT.7/16-1.1/4-13
REF A=34.4 REF B=52.36



DIESEL TOOLS

MRD-3675 REF C 70.87
JGO |DAD.1/2.LARG/
COR.32P.NEUMA.8-32M-32
REF A=44.24 REF B=67.33



CONTENTS:
2PCS-1/2"SPARK PLUG SOCKET-16MMX21MM
1PCS-1/2" X 10 EXTENSION BAR
1PCS-3-WAY ADAPTOR
1PCS-1/2" RATCHET HANDLE
12PCS-WRENCH-8,9,10,11,12,13,14,15,16,17,18,19MM
1PCS-1/2" SOCKETS(SPT)-8,9,10,11,12,13,14,15,16,17,18,19,20,21,22,27,30,32MM

MAXI TOOLS

MRD-3690 REF C 52.96
JGO |DADOS/LLAV.8-32M Y 8-19M 37PC
MX037
REF A=33.06 REF B=50.31

1PCS-1/2 DR SOCKET-10,11,12,13,14,15,16,17,18,19,20,21,22,24,27,30,32MM
5PCS-1/2 DEEP SOCKET-14,15,17,19,22MM
2PCS-1/2 EXTENSION BAR-128MM+250MM
8PCS-1/2 E-TYPE SLEEVE- E10,E11,E12 AT 11,45, E14 E16 E18 E20 E24
1PC-1/2 RATCHET HANDLE
1PC-1/2-WAY ADAPTOR
12PCS-1/4 DR SOCKET- 4,4.5,5.5,6,7,8,9,10,11,12,13,14MM
8PCS-1/4 DEEP SOCKET- 6,7,8,9,10,11,12,13MM
1PC-1/4 UNIVERSAL JOINT
1PCS-1/4 E-TYPE SLEEVE- EA,EE,EE6,EE7,EE8
1PC-1/4 BITS
1PCS-BATCH OF HEAD SLEEVE
1PC-BATCH OF HEAD WRENCHES
1PC-1/2 UNIVERSAL JOINT
2PCS-1/2 WARRS- 18 AND 21MM
2PCS-1/4 EXTENSION BAR-160MM+175MM
1PC-1/4 RATCHET HANDLE
2PCS-HEX SOCKET
1PCS-BITS

MAXI TOOLS

MRD-3710 REF C 76.2
JGO |DAD.COMB+RACH.108PC SURTIDOS
MX901A
REF A=47.56 REF B=72.39



DIESEL TOOLS

MRD-3750 REF C 138.61
JGO |DADOS 3/4"JGO 21P
3/4-2"+RATCH.Y021
REF A=86.52 REF B=131.69



DIESEL TOOLS

MRD-3760 REF C 204.74
JGO |DADOS 3/4"JGO.22PC
19-50M+RACH.3422
REF A=127.81 REF B=194.52

CONTENTS:
19pcs sockets: 19, 21, 22, 23, 24, 26, 27, 30, 32, 34, 36, 38, 41, 46, 48, 50mm
3pcs extension bars: 100, 200, 400mm
1pc ratchet wrench
1pc sliding bar



DIESEL TOOLS

MRD-3860 REF C 8.51
PZA |DADOS CARDAN JG 3PZ
1/4/3/8/1/2"J03
REF A=5.31 REF B=8.08



DIESEL TOOLS

MRD-3875 REF C 4.25
PZA |DAD.BUJIA 3/8 3P.5/8x13/16x23/32
94
REF A=2.66 REF B=4.04



DIESEL TOOLS

MRD-6650 REF C 5.67
PZA |PALANCA DE FUERZA D-1/4" X
6"DTF014
REF A=3.54 REF B=5.39



DIESEL TOOLS

MRD-6655 REF C 6.63
PZA |PALANCA DE FUERZA D-3/8" X
8"DTF038
REF A=4.14 REF B=6.3



1/2"x15"



MRD-6700 REF C 11.02
PZA | PALANCA FUERZA ARTIC. 1/2"x15
DTFH12

REF A=6.88 REF B=10.47



1/2x18"



MRD-6710 REF C 16.37
PZA | PALANCA DE FUERZA D-1/2" X 18" Q7

REF A=10.22 REF B=15.56



1/2"x24"



MRD-6717 REF C 26.35
PZA | PALANC.FUERZA
ARTICULAD. 1/2"x24"006

REF A=16.45 REF B=25.03



3/4"x19mm
x500mm



MRD-6770 REF C 17.22
PZA | PALANCA D/FUERZA 3/4X19MX500M
DS419

REF A=10.75 REF B=16.36



1/4"

MRD-7150 REF C 6.13
PZA | RATCHET 1/4 MAGO GOMA CROMADO

REF A=3.82 REF B=5.82



3/8"



MRD-7190 REF C 5.68
PZA | RATCHET DE 3/8" MANG. CRO FM/URS
IMP

REF A=5.43 REF B=5.99



3/8x1/2"



MRD-7210 REF C 7.68
PZA | RATCHET 3/8 X 1/2 CORTO DIESEL
072

REF A=4.79 REF B=7.29



3/8x1/2"



MRD-7220 REF C 12.25
PZA | RATCHET 3/8 X 1/2 LARGO DIESEL
0073

REF A=7.65 REF B=11.64



1/2"



MRD-7285 REF C 7.25
PZA | RATCHET 1/2" MANG./GOM. CROM DT-
TL001

REF A=4.53 REF B=6.89

608.2RS.C3



HLB
Famous Trademark

RLN-2000 REF C 1.05
PZA | RODAMIENTO JAPAN HLB 608.2RS.C3

REF A=0.65 REF B=0.99

608.ZZ.C3



HLB
Famous Trademark

RLN-2010 REF C 1.05
PZA | RODAMIENTO JAPAN HLB 608.ZZ C3

REF A=0.65 REF B=0.99

6005.2RS.C3



HLB
Famous Trademark

RLN-4100 REF C 3.31
PZA | RODAMIENTO JAPAN HLB 6005.2RS.C3

REF A=2.07 REF B=3.15

6200.2RS.C3



HLB
Famous Trademark

RLN-4200 REF C 1.24
PZA | RODAMIENTO JAPAN HLB 6200.2RS.C3

REF A=0.78 REF B=1.18

6201.2RS.C3



HLB
Famous Trademark

RLN-4295 REF C 1.24
PZA | RODAMIENTO JAPAN HLB 6201.2RS.C3

REF A=0.78 REF B=1.18

**6201.1/2
2RS.C3**



HLB
Famous Trademark

RLN-4305 REF C 1.97
PZA | RODAMIENT JAPAN HLB
6201.1/2.2RS.C3

REF A=1.23 REF B=1.87

6202.2RS.C3



HLB
Famous Trademark

RLN-4385 REF C 2.07
PZA | RODAMIENTO JAPAN HLB 6202.2RS.C3

REF A=1.29 REF B=1.97

6202.ZZ.C3



HLB
Famous Trademark

RLN-4388 REF C 2.07
PZA | RODAMIENTO JAPAN HLB 6202.ZZ.C3

REF A=1.29 REF B=1.97

6203.2RS.C3



HLB
Famous Trademark

RLN-4498 REF C 2.07
PZA | RODAMIENTO JAPAN HLB 6203.2RS.C3

REF A=1.29 REF B=1.97

6303.2RS.C3



HLB
Famous Trademark

RLN-4898 REF C 3.56
PZA | RODAMIENTO JAPAN HLB 6303.2RS.C3

REF A=2.22 REF B=3.38

6304.2RS.C3



HLB
Famous Trademark

RLN-5000 REF C 4.02
PZA | RODAMIENTO JAPAN HLB 6304.2RS.C3

REF A=2.51 REF B=3.82

6305.ZZ.C3



HLB
Famous Trademark

RLN-5100 REF C 5.31
PZA | RODAMIENTO JAPAN HLB 6305.ZZ.C3

REF A=3.31 REF B=5.04

6310.2RS.C3



HLB
Famous Trademark

RLN-5600 REF C 16.97
PZA | RODAMIENTO JAPAN HLB 6310.2RS.C3

REF A=10.59 REF B=16.12



SAG-0300 REF C 7.16
PZA | ENVASE PLAST.P/P.DE
GRAVED.M:M990

REF A=4.47 REF B=6.8

1/2"



MA
Tools

SAG-0405 REF C 52.49
PZA | FILTRO REG P/AIRE D/COMPRES.1/2
NPT

REF A=32.77 REF B=49.87



Q7

SAG-0760 REF C 34.65
KIT | KIT 14 PZA P/COMPRESOR AIRE MT-
K14

REF A=21.63 REF B=32.92



Q7

SAG-0761 REF C 27.72
KIT | KIT 20 PZA P/COMPRESOR AIRE MT-
K20

REF A=17.3 REF B=26.33



DIESEL TOOLS

SAG-0765 REF C 44.09
JGO | KIT PINT(PIST,AIRE,P/
DUCH,MAG)5pzDS

REF A=27.52 REF B=41.89



SAG-0787 REF C 25.2
PZA | PISTOLA P/PETROLEAR ROSSI DG-10W

REF A=15.73 REF B=23.94



SAG-0790 REF C 18.89
PZA | PISTOLA PETROLER.ROJO/FERM DO-10

REF A=11.79 REF B=17.94



750ML



SAG-0795 REF C 24.88
PZA | PIST.PINTAR.B/PRESION 750M ROS/
CROW

REF A=15.53 REF B=23.64



SAG-0804 REF C 51.31
PZA | PIST.PINTAR PROF.ALT/PRES.FMT P-07

REF A=32.03 REF B=48.75



SAG-0807 REF C 45.66
PZA | PIST.PINT.PROF.T/SG.NA2011 C/
KIT.PA

REF A=28.5 REF B=43.38



SAG-0810 REF C 54.66
PZA | PISTOL.PINT.PROF.T/SAGOLA 4001
ROSS

REF A=34.12 REF B=51.93



200ML



SAG-0813 REF C 21.43
PZA | PIST.PINTAR GRAVEDAD 200ML
ALUM.CROW

REF A=13.38 REF B=20.36



SAG-0815 REF C 31.17
PZA | PISTOLA PINTAR D/GRAVEDA.S990C
ROS

REF A=19.46 REF B=29.61



600ML



SAG-0817 REF C 42.51
PZA | PIST.PINTAR.GRAVEDAD.PLAST.600ML
CRO

REF A=26.54 REF B=40.39



SAG-0900 REF C 6.85
PZA | PISTOLA P/SOPLAR AIRE ITALIA F.G

REF A=4.28 REF B=6.51



1/4"



SAG-0902 REF C 3.93
PZA | PIST.SOPLAR AIRE 1/4 PIC/
LARG.CROWN

REF A=2.45 REF B=3.74



SAG-0904 REF C 10.62
PZA | PIST.INFLAR CAUCHO+MANOM.220PSI
043

REF A=6.63 REF B=10.09



SAG-0907 REF C 4.9
PZA | PISTOLA DE AIRE JUEGO 7 PCS
WOLFGAN

REF A=3.06 REF B=4.65



SAG-0920 REF C 51.24
PZA | PIST.P/ASFALT.Y ARENAR(SAND
BLASTING

REF A=31.99 REF B=48.68



**15A-125V
E-27**

SOC-2104 REF C 0.38
PZA | SOCATE GOMA/INTERIOR
PORCELAN.E-27

REF A=0.24 REF B=0.36



**40%ESTAÑO
60%PLOMO
0.8mm**



SOL-9920 REF C 1.34
PZA | SOLDADURA ESTAÑO TUBITO 60/40
0.8MM

REF A=0.84 REF B=1.27



**40%ESTAÑO
60%PLOMO
1.00mm**



SOL-9924 REF C 5.09
RLL | SOLDADURA C/RES.40/60 1.0MM
100G CF

REF A=3.18 REF B=4.83



**13mts x 1.0mm
80grs**



SOL-9925 REF C 1.28
RLL | SOLDAD.C/RESIN.1.0m 13MTS.80GR
DIES

REF A=0.8 REF B=1.22

**1.00mm
x225gr**



SOL-9927 REF C 8.8
RLL | SOLDAD.C/RESIN.1.0m 225GRS
35mts DT
REF A=5.49 REF B=8.36

**400ML
LIMON**



SPR-0979 REF C 3.91
PZA | SPR.SILICON LIMON MULT.USO 400ML
Q7
REF A=2.44 REF B=3.71

**378ml
OLOR FRESA**



SPR-0980 REF C 3.58
PZA | SPRAY SILICONA FRESA 400ML UDEKE
REF A=2.24 REF B=3.41

**378ml
OLOR LIMON**



SPR-0983 REF C 3.58
PZA | SPRAY SILICONA LIMON 400ML UDEKE
REF A=2.24 REF B=3.41

**378ml
OLOR UVA**



SPR-0986 REF C 3.58
PZA | SPRAY SILICONA UVA 400ML UDEKE
REF A=2.24 REF B=3.41

450ML



SPR-0990 REF C 4.01
PZA | SPRAY FORMULA MECANICA 450ML
ZASC
REF A=2.51 REF B=3.81

650ml



SPR-1002 REF C 3.48
PZA | S.LIMPIAD/MULT.TAPICER.ESPUM.650
Q7
REF A=2.17 REF B=3.3

500ml



SPR-1007 REF C 4.25
PZA | SPR.LIMPIAD.MOTOR EN ESPUMA
650M ZA
REF A=2.66 REF B=4.04

450ml



SPR-1015 REF C 4.09
PZA | SPRAY.LIMPIADOR CONTACTO 450ML
Q7
REF A=2.56 REF B=3.89



650ml

Q7

SPR-1017 REF C 3.48
PZA | SPR.LIMPIADOR/ABRILL.CAUCHO
650M Q7
REF A=2.17 REF B=3.3



650ml

ZASC

SPR-1018 REF C 4.98
PZA | SPR.LIMPIAD.ESPUMA.CAUCHO 650M
ZASC
REF A=3.11 REF B=4.73



450ml

DIESEL TOOLS

SPR-1025 REF C 3.8
PZA | SPRAY LIMPIAD.CARBURADOR 450M
DIESE
REF A=2.37 REF B=3.61



100ml

DIESEL TOOLS

SPR-1030 REF C 2.62
PZA | SPR.ACEITE PENETRANTE 100ML
DIES300
REF A=1.64 REF B=2.49



210ml

DIESEL TOOLS

SPR-1031 REF C 3
PZA | SPR.ACEITE PENETRANTE 210ML
DIES300
REF A=1.87 REF B=2.85



450ml

UDUKE

SPR-1032 REF C 3.77
PZA | SPR.ACEITE PENETRANTE 450ML 303
UDE
REF A=2.35 REF B=3.58



450ml

ZASC

SPR-1033 REF C 4.01
PZA | SP.LUBRIC.ANTICOR.FORMUL.MARINA
450
REF A=2.51 REF B=3.81



450ml

Q7

SPR-1040 REF C 3.8
PZA | SPRAY GRASA LIQUIDA
TRANSP.400ML Q7
REF A=2.37 REF B=3.61



**100W
200-500°C**

**TOTAL
TOOLS**



TOT-0200 REF C 12.16
PZA | CAUTIN 100WT 120V 500øC TOTAL
831
REF A=7.59 REF B=11.56



**12/24V
8/5A**



TOTAL

TOT-0250 REF C 103.41
PZA | CARGAD. BATERIA 120V 12/24V
8/5A1601
REF A=64.55 REF B=98.25



7PCS



TOTAL

TOT-1570 REF C 23.76
SET | ESCUAD. MAGNETICA SOLDADURA
7PC 7006
REF A=14.83 REF B=22.57



**4.4kg
1200W**



TOTAL

TOT-2800 REF C 136.95
PZA | HIDROLAVADORA MINI 1200W 120V
3026
REF A=85.49 REF B=130.11



1400W

TOTAL

TOT-2807 REF C 145.33
PZA | HIDROLAVADORA 1400W 120V 5.5L/
M 316
REF A=90.72 REF B=138.07



1TON

VIT-6500 REF C 14.96
PZA | SEÑORITA GUAYA MANUAL
1TON.MXTX0001
REF A=9.34 REF B=14.21



2TON

VIT-6505 REF C 18.7
PZA | SEÑORITA GUAYA MANUAL 2
TON.MXTX002
REF A=11.67 REF B=17.76



3TON

VIT-6510 REF C 19.53
PZA | SEÑORITA GUAYA MANUAL 3
TON.MXTX003
REF A=12.19 REF B=18.55



**5TON
x3MTS**

VIT-6630 REF C 222.58
PZA | SEÑORITA CADENA 5 TON.DIESEL
21/5T
REF A=138.94 REF B=211.47



1TONx3M

VIT-6640 REF C 151.21
PZA | SEÑORITA 1 TON. 3mt CADENA
CROWNAMN
REF A=94.39 REF B=143.66



2TONx3M



CROWNMAN
PROFESSIONAL

VIT-6643 REF C 195.3
PZA | SEYORITA 2 TON. 3mt CADENA
CROWNAMN
REF A=121.91 REF B=185.55



3TONx3M



CROWNMAN
PROFESSIONAL

VIT-6646 REF C 267.75
PZA | SEYORITA 3 TON. 3mt CADENA
CROWNAMN
REF A=167.13 REF B=254.38



2TON



VITAL

VIT-6995 REF C 252.4
PZA | SEYORITA D/CADENA VITAL 2 TON
REF A=157.55 REF B=239.8